

SNOWSOUND

Acoustics & Wellbeing technologies

Caimi

PRODUCTS LIST

MODULO BASE BASE UNIT L. 120

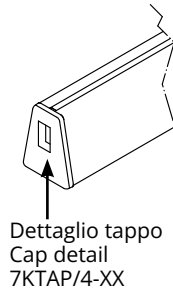
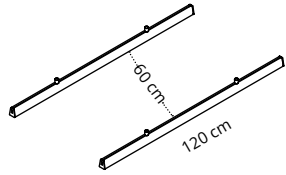

7KFRAME1-AL
Alluminio
Aluminium
Aluminium
Aluminio
Aluminium

Struttura base attacco diretto a soffitto.
Composta da:
Base structure direct ceiling connection.
Composed of
Structure de base connexion directe au
plafond. Composé par :
Estructura básica conexión directa al
techo. Compuesto por:
Basisstruktur direkt an der Decke befestigt.
Bestehend aus:

7KFRAME1-N
Nero
Black
Noir
Negro
Schwarz

1 - 7K120P/2-XX
1 - 7KTAP/4-XX
1 - 7KAD/4-NI

Numero massimo pannelli uniformemente distribuiti per queste strutture:
Maximum number of evenly distributed panels for these structures:
Nombre maximal de panneaux uniformément répartis pour ces structures :
Número máximo de paneles distribuidos uniformemente para estas estructuras:
Maximale Anzahl von gleichmäßig verteilten Paneelen für diese Strukturen:

INDUSTRIAL 24 mm PANELS



120x80 max 6 pcs
120x20 max 12 pcs

MODULO SEGUITO ADD-ON UNIT L. 120

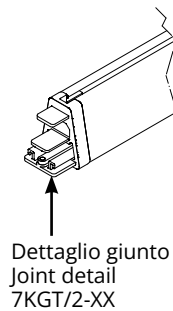
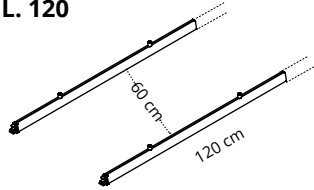

7KFRAME1S-AL
Alluminio
Aluminium
Aluminium
Aluminio
Aluminium

Struttura seguito attacco diretto a soffitto. Composta da:
Add-on structure direct ceiling connection. Composed of
Structure suivante connexion directe au plafond. Composé par :
Estructura seguida conexión directa al techo. Compuesto por:
Zusatzstruktur mit direktem Deckenan-schluss. Bestehend aus:

7KFRAME1S-N
Nero
Black
Noir
Negro
Schwarz

1 - 7K120P/2-XX
1 - 7KGT/2-XX
1 - 7KAD/4-NI

INDUSTRIAL 40 mm PANELS

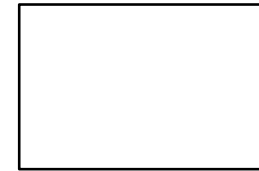

120x80 max 6 pcs
120x20 max 12 pcs

MODULO BASE BASE UNIT L. 120

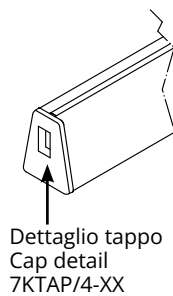
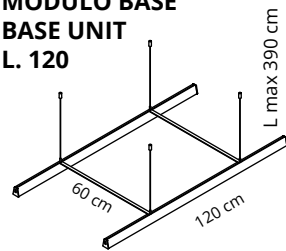

7KFRAME5-AL
Alluminio
Aluminium
Aluminium
Aluminio
Aluminium

Struttura base attacco a soffitto con cavi
Composta da:
Base structure with cable ceiling attachment. Consisting of:
Structure de base avec fixation par câbles au plafond. Composé par :
Estructura base con fijación a techo por cable. Formada por:
Basisstruktur mit Kabel-Deckenbefestigung. Bestehend aus:

7KFRAME5-N
Nero
Black
Noir
Negro
Schwarz

1 - 7K120P/2-XX / 1 - 7K60D/2-XX
1 - 7KTAP/4-XX / 1 - 7KAC/4-NI

SNOWSOUND PANELS

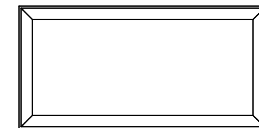

119x59 max 6 pcs
119x44 max 6 pcs

MODULO SEGUITO ADD-ON UNIT L. 120

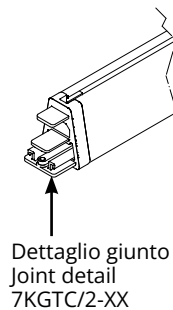
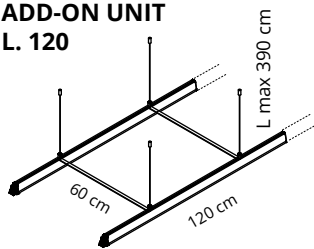

7KFRAME5S-AL
Alluminio
Aluminium
Aluminium
Aluminio
Aluminium

Struttura seguito attacco a soffitto con cavi.
Composta da:
Add-on structure with cable ceiling attachment. Consisting of:
Structure suivante avec fixation par câbles au plafond. Composé par :
Estructura seguida con fijación a techo por cable. Formada por:
Zusatzstruktur gefolgt von einer Deckenbefestigung mit Kabeln. Bestehend aus:

7KFRAME5S-N
Nero
Black
Noir
Negro
Schwarz

1 - 7K120P/2-XX / 1 - 7K60D/2-XX
1 - 7KGTC/2-XX / 1 - 7KAC/4-NI

SNOWSOUND TEXTILES PANELS

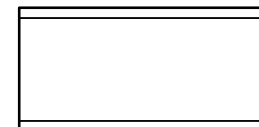

119x80 max 6 pcs
119x60 max 6 pcs
119x40 max 12 pcs

MODULO BASE BASE UNIT L. 120

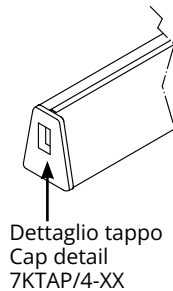
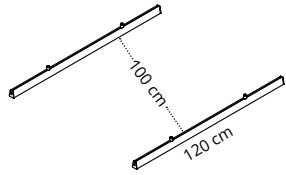

Dettaglio tappo
Cap detail
7KTAP/4-XX

7KFRAME1-AL
Alluminio
Aluminium
Aluminium
Aluminio
Aluminium

Struttura base attacco diretto a soffitto.
Composta da:
Base structure direct ceiling connection.
Composed of
Structure de base connexion directe au
plafond. Composé par :
Estructura básica conexión directa al
techo. Compuesto por:
Basisstruktur direkt an der Decke befestigt.
Bestehend aus:

7KFRAME1-N
Nero
Black
Noir
Negro
Schwarz

1 - 7K120P/2-XX
1 - 7KTAP/4-XX
1 - 7KAD/4-NI

Numero massimo pannelli uniformemente distribuiti per queste strutture:
Maximum number of evenly distributed panels for these structures:
Nombre maximal de panneaux uniformément répartis pour ces structures :
Número máximo de paneles distribuidos uniformemente para estas estructuras:
Maximale Anzahl von gleichmäßig verteilten Paneelen für diese Strukturen:

INDUSTRIAL 24 mm PANELS



160x60 max 6 pcs
160x40 max 8 pcs
160x20 max 12 pcs

MODULO SEGUITO ADD-ON UNIT L. 120

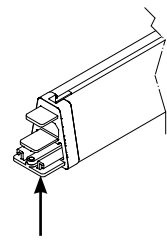
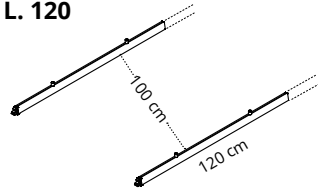

Dettaglio giunto
Joint detail
7KGT/2-XX

7KFRAME1S-AL
Alluminio
Aluminium
Aluminium
Aluminio
Aluminium

Struttura seguito attacco diretto a soffitto.
Composta da:
Add-on structure direct ceiling connection.
Composed of
Structure suivante connexion directe au
plafond. Composé par :
Estructura seguida conexión directa al
techo. Compuesto por:
Zusatzstruktur mit direktem Deckenan-
schluss. Bestehend aus:

7KFRAME1S-N
Nero
Black
Noir
Negro
Schwarz

1 - 7K120P/2-XX
1 - 7KGT/2-XX
1 - 7KAD/4-NI

INDUSTRIAL 40 mm PANELS



160x60 max 6 pcs
160x40 max 8 pcs
160x20 max 12 pcs

MODULO BASE BASE UNIT L. 120

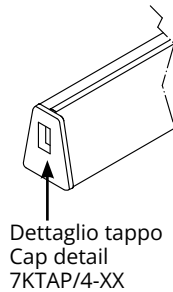
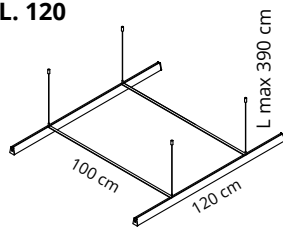

Dettaglio tappo
Cap detail
7KTAP/4-XX

7KFRAME6-AL
Alluminio
Aluminium
Aluminium
Aluminio
Aluminium

Struttura base attacco a soffitto con cavi
Composta da:
Base structure with cable ceiling attachment. Consisting of:
Structure de base avec fixation par câbles
au plafond. Composé par :
Estructura base con fijación a techo por
cable. Formada por:
Basisstruktur mit Kabel-Deckenbefestigung.
Bestehend aus:

7KFRAME6-N
Nero
Black
Noir
Negro
Schwarz

1 - 7K120P/2-XX / 1 - 7K100D/2-XX
1 - 7KTAP/4-XX / 1 - 7KAC/4-NI

SNOWSOUND PANELS

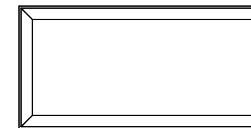

159x59 max 6 pcs
159x44 max 6 pcs
159x22 max 12 pcs

MODULO SEGUITO ADD-ON UNIT L. 120

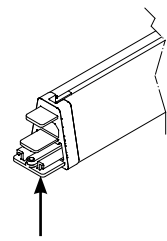
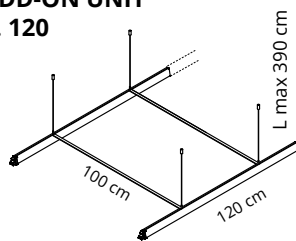

Dettaglio giunto
Joint detail
7KGTC/2-XX

7KFRAME6S-AL
Alluminio
Aluminium
Aluminium
Aluminio
Aluminium

Struttura seguito attacco a soffitto con
cavi. Composta da:
Add-on structure with cable ceiling attachment. Consisting of:
Structure suivante avec fixation par câbles
au plafond. Composé par :
Estructura seguida con fijación a techo
por cable. Formada por:
Zusatzstruktur gefolgt von einer Decken-
befestigung mit Kabeln. Bestehend aus:

7KFRAME6S-N
Nero
Black
Noir
Negro
Schwarz

1 - 7K120P/2-XX / 1 - 7K100D/2-XX
1 - 7KGTC/2-XX / 1 - 7KAC/4-NI

SNOWSOUND TEXTILES PANELS

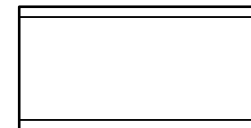

159x80 max 6 pcs
159x60 max 6 pcs
159x40 max 6 pcs

MODULO BASE BASE UNIT L. 180

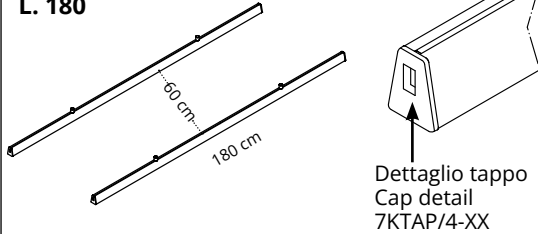

7KFRAME3-AL
Alluminio
Aluminium
Aluminium
Aluminio
Aluminium

Struttura base attacco diretto a soffitto.
Composta da:
Base structure direct ceiling connection.
Composed of
Structure de base connexion directe au
plafond. Composé par :
Estructura básica conexión directa al
techo. Compuesto por:
Basisstruktur direkt an der Decke befestigt.
Bestehend aus:

7KFRAME3-N
Nero
Black
Noir
Negro
Schwarz

1 - 7K180P/2-XX
1 - 7KTAP/4-XX
1 - 7KAD/4-NI

Numero massimo pannelli uniformemente distribuiti per queste strutture:
Maximum number of evenly distributed panels for these structures:
Nombre maximal de panneaux uniformément répartis pour ces structures :
Número máximo de paneles distribuidos uniformemente para estas estructuras:
Maximale Anzahl von gleichmäßig verteilten Paneelen für diese Strukturen:

MODULO SEGUITO ADD-ON UNIT L. 180

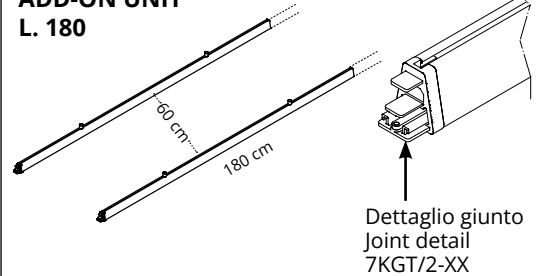

7KFRAME3S-AL
Alluminio
Aluminium
Aluminium
Aluminio
Aluminium

Struttura seguito attacco diretto a soffitto. Composta da:
Add-on structure direct ceiling connection. Composed of
Structure suivante connexion directe au plafond. Composé par :
Estructura seguida conexión directa al techo. Compuesto por:
Zusatzstruktur mit direktem Deckenan-schluss. Bestehend aus:

7KFRAME3S-N
Nero
Black
Noir
Negro
Schwarz

1 - 7K180P/2-XX
1 - 7KGT/2-XX
1 - 7KAD/4-NI

INDUSTRIAL 24 mm PANELS



120x80 max 6 pcs
120x20 max 12 pcs

MODULO BASE BASE UNIT L. 180

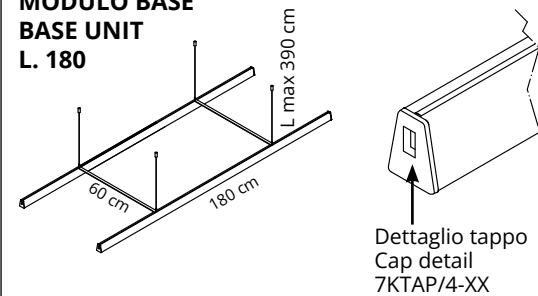

7KFRAME7-AL
Alluminio
Aluminium
Aluminium
Aluminio
Aluminium

Struttura base attacco a soffitto con cavi
Composta da:
Base structure with cable ceiling attachment. Consisting of:
Structure de base avec fixation par câbles au plafond. Composé par :
Estructura base con fijación a techo por cable. Formada por:
Basisstruktur mit Kabel-Deckenbefestigung. Bestehend aus:

7KFRAME7-N
Nero
Black
Noir
Negro
Schwarz

1 - 7K180P/2-XX / 1 - 7K60D/2-XX
1 - 7KTAP/4-XX / 1 - 7KAC/4-NI

SNOWSOUND PANELS

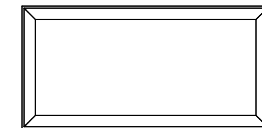

119x59 max 6 pcs
119x44 max 6 pcs

MODULO SEGUITO ADD-ON UNIT L. 180

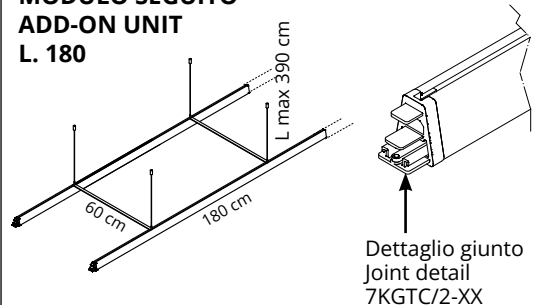

7KFRAME7S-AL
Alluminio
Aluminium
Aluminium
Aluminio
Aluminium

Struttura seguito attacco a soffitto con cavi.
Composta da:
Add-on structure with cable ceiling attachment. Consisting of:
Structure suivante avec fixation par câbles au plafond. Composé par :
Estructura seguida con fijación a techo por cable. Formada por:
Zusatzstruktur gefolgt von einer Deckenbefestigung mit Kabeln. Bestehend aus:

7KFRAME7S-N
Nero
Black
Noir
Negro
Schwarz

1 - 7K180P/2-XX / 1 - 7K60D/2-XX
1 - 7KGTC/2-XX / 1 - 7KAC/4-NI

SNOWSOUND TEXTILES PANELS

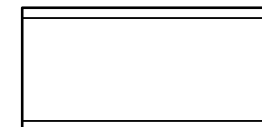

119x80 max 6 pcs
119x60 max 6 pcs
119x40 max 12 pcs

MODULO BASE BASE UNIT L. 180

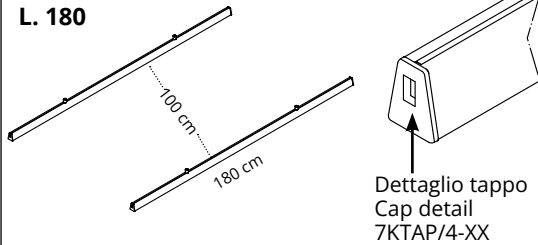

7KFRAME3-AL
Alluminio
Aluminium
Aluminium
Aluminium
Aluminium

Struttura base attacco diretto a soffitto.
Composta da:
Base structure direct ceiling connection.
Composed of
Structure de base connexion directe au
plafond. Composé par :
Estructura básica conexión directa al
techo. Compuesto por:
Basisstruktur direkt an der Decke befestigt.
Bestehend aus:

7KFRAME3-N
Nero
Black
Noir
Negro
Schwarz

1 - 7K180P/2-XX
1 - 7KTAP/4-XX
1 - 7KAD/4-NI

Numero massimo pannelli uniformemente distribuiti per queste strutture:
Maximum number of evenly distributed panels for these structures:
Nombre maximal de panneaux uniformément répartis pour ces structures :
Número máximo de paneles distribuidos uniformemente para estas estructuras:
Maximale Anzahl von gleichmäßig verteilten Paneelen für diese Strukturen:

INDUSTRIAL 24 mm PANELS



160x60 max 6 pcs
160x40 max 8 pcs
160x20 max 12 pcs

MODULO SEGUITO ADD-ON UNIT L. 180

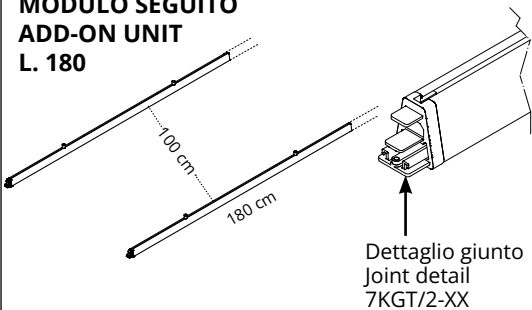

7KFRAME3S-AL
Alluminio
Aluminium
Aluminium
Aluminium
Aluminium

Struttura seguito attacco diretto a soffitto. Composta da:
Add-on structure direct ceiling connection. Composed of
Structure suivante connexion directe au plafond. Composé par :
Estructura seguida conexión directa al techo. Compuesto por:
Zusatzstruktur mit direktem Deckenan-schluss. Bestehend aus:

7KFRAME3S-N
Nero
Black
Noir
Negro
Schwarz

1 - 7K180P/2-XX
1 - 7KGT/2-XX
1 - 7KAD/4-NI

INDUSTRIAL 40 mm PANELS



160x60 max 6 pcs
160x40 max 8 pcs
160x20 max 12 pcs

MODULO BASE BASE UNIT L. 180

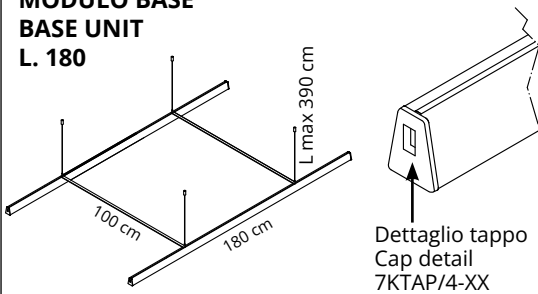

7KFRAME8-AL
Alluminio
Aluminium
Aluminium
Aluminium
Aluminium

Struttura base attacco a soffitto con cavi
Composta da:
Base structure with cable ceiling attachment. Consisting of:
Structure de base avec fixation par câbles au plafond. Composé par :
Estructura base con fijación a techo por cable. Formada por:
Basisstruktur mit Kabel-Deckenbefestigung. Bestehend aus:

7KFRAME8-N
Nero
Black
Noir
Negro
Schwarz

1 - 7K180P/2-XX / 1 - 7K100D/2-XX
1 - 7KTAP/4-XX / 1 - 7KAC/4-NI

SNOWSOUND PANELS

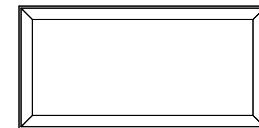

159x59 max 6 pcs
159x44 max 6 pcs
159x22 max 12 pcs

MODULO SEGUITO ADD-ON UNIT L. 180

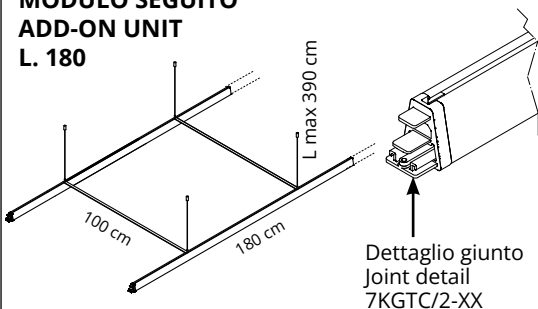

7KFRAME8S-AL
Alluminio
Aluminium
Aluminium
Aluminium
Aluminium

Struttura seguito attacco a soffitto con cavi.
Composta da:
Add-on structure with cable ceiling attachment. Consisting of:
Structure suivante avec fixation par câbles au plafond. Composé par :
Estructura seguida con fijación a techo por cable. Formada por:
Zusatzstruktur gefolgt von einer Deckenbefestigung mit Kabeln. Bestehend aus:

7KFRAME8S-N
Nero
Black
Noir
Negro
Schwarz

1 - 7K180P/2-XX / 1 - 7K100D/2-XX
1 - 7KGTC/2-XX / 1 - 7KAC/4-NI

SNOWSOUND TEXTILES PANELS

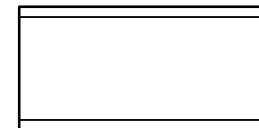

159x80 max 6 pcs
159x60 max 6 pcs
159x40 max 6 pcs

SNOWSOUND-UP / INDUSTRIAL 24 mm PANELS

Pannelli Industrial spessore 24 mm - Appendimento a "baffle" e supporti per aggancio pannelli Industrial ai profili. Ogni pannello necessita di una coppia di supporti.
 24 mm thick Industrial panels - Baffle hangers and supports for attaching Industrial panels to profiles. Each panel requires a pair of supports.
 Panneaux Industrial de 24 mm d'épaisseur - Supports et suspensions pour fixer les panneaux Industrial aux profilés. Chaque panneau nécessite d'une paire de supports.
 Paneles Industrial de 24 mm de grosor - Colgadores y soportes para fijar los paneles Industrial a los perfiles. Cada panel requiere un par de soportes.
 24 mm dicke Industrial Paneele - Aufhängung und Einhängehalterungen für die Befestigung von Industrial-Paneelen an Profilen. Jedes Paneel benötigt ein Paar Halterungen.

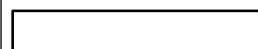
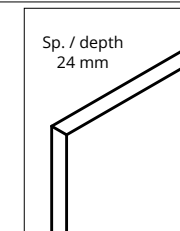

120X20 cm

Bianco
White**7IN122/12-B25**Scatola da 12 pz.
Box of 12 pcs.

+

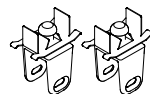
**1 code 7KGIN25/24-N**Nero
Black 12 coppie
12 pairs**o / or 1 code 7KGIN25/24-AL**Alluminio
Aluminium 12 coppie
12 pairs

120X80 cm

Bianco
White**7IN128/6-B25**Scatola da 6 pz.
Box of 6 pcs.

+

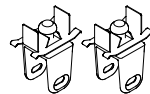
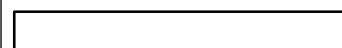
**1 code 7KGIN25/12-N**Nero
Black 6 coppie
6 pairs**o / or 1 code 7KGIN25/12-AL**Alluminio
Aluminium 6 coppie
6 pairs

160X20 cm

Bianco
White**7IN162/12-B25**Scatola da 12 pz.
Box of 12 pcs.

+

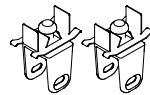
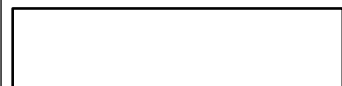
**1 code 7KGIN25/24-N**Nero
Black 12 coppie
12 pairs**o / or 1 code 7KGIN25/24-AL**Alluminio
Aluminium 12 coppie
12 pairs

160X40 cm

Bianco
White**7IN164/6-B25**Scatola da 6 pz.
Box of 6 pcs.

+

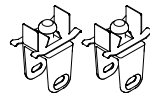
**1 code 7KGIN25/12-N**Nero
Black 6 coppie
6 pairs**o / or 1 code 7KGIN25/12-AL**Alluminio
Aluminium 6 coppie
6 pairs

160X60 cm

Bianco
White**7IN166/6-B25**Scatola da 6 pz.
Box of 6 pcs.

+

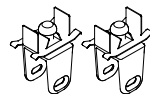
**1 code 7KGIN25/12-N**Nero
Black 6 coppie
6 pairs**o / or 1 code 7KGIN25/12-AL**Alluminio
Aluminium 6 coppie
6 pairs

Per effettuare l'ordine: 1) indicare il codice del pannello 2) indicare la scelta dei supporti

To place the order: 1) select panel code 2) select supports

Pour passer la commande : 1) indiquer le code du panneau 2) indiquer le choix des supports

Para realizar el pedido: 1) indique el código del panel 2) indique la elección de soportes

Um das zu bestellen: 1) den Code des Paneels angeben 2) die Halterungen angeben

Pannelli Industrial spessore 24 mm - Appendimento a "baffle" e supporti per aggancio pannelli Industrial ai profili. Ogni pannello necessita di una coppia di supporti.
 24 mm thick Industrial panels - Baffle hangers and supports for attaching Industrial panels to profiles. Each panel requires a pair of supports.
 Panneaux Industrial de 24 mm d'épaisseur - Supports et suspensions pour fixer les panneaux Industrial aux profilés. Chaque panneau nécessite d'une paire de supports.
 Paneles Industrial de 24 mm de grosor - Colgadores y soportes para fijar los paneles Industrial a los perfiles. Cada panel requiere un par de soportes.
 24 mm dicke Industrial Paneele - Aufhängung und Einhängehalterungen für die Befestigung von Industrial-Paneelen an Profilen. Jedes Paneel benötigt ein Paar Halterungen.

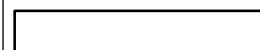
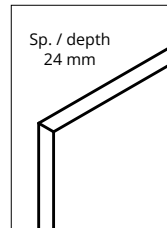

120X20 cm

Nero
Black**7IN122/12-N25**Scatola da 12 pz.
Box of 12 pcs.

+

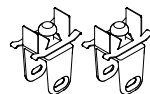
**1 code 7KGIN25/24-N**Nero
Black12 coppie
12 pairs**o / or 1 code 7KGIN25/24-AL**Alluminio
Aluminium12 coppie
12 pairs

120X80 cm

Nero
Black**7IN128/6-N25**Scatola da 6 pz.
Box of 6 pcs.

+

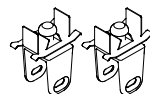
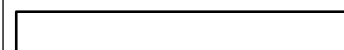
**1 code 7KGIN25/12-N**Nero
Black6 coppie
6 pairs**o / or 1 code 7KGIN25/12-AL**Alluminio
Aluminium6 coppie
6 pairs

160X20 cm

Nero
Black**7IN162/12-N25**Scatola da 12 pz.
Box of 12 pcs.

+

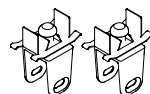
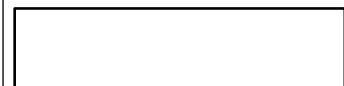
**1 code 7KGIN25/24-N**Nero
Black12 coppie
12 pairs**o / or 1 code 7KGIN25/24-AL**Alluminio
Aluminium12 coppie
12 pairs

160X40 cm

Nero
Black**7IN164/6-N25**Scatola da 6 pz.
Box of 6 pcs.

+

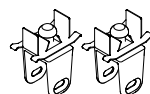
**1 code 7KGIN25/12-N**Nero
Black6 coppie
6 pairs**o / or 1 code 7KGIN25/12-AL**Alluminio
Aluminium6 coppie
6 pairs

160X60 cm

Nero
Black**7IN166/6-N25**Scatola da 6 pz.
Box of 6 pcs.

+

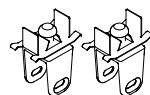
**1 code 7KGIN25/12-N**Nero
Black6 coppie
6 pairs**o / or 1 code 7KGIN25/12-AL**Alluminio
Aluminium6 coppie
6 pairs

Per effettuare l'ordine: 1) indicare il codice del pannello 2) indicare la scelta dei supporti

To place the order: 1) select panel code 2) select supports

Pour passer la commande : 1) indiquer le code du panneau 2) indiquer le choix des supports

Para realizar el pedido: 1) indique el código del panel 2) indique la elección de soportes

Um das zu bestellen: 1) den Code des Paneels angeben 2) die Halterungen angeben

SNOWSOUND-UP / INDUSTRIAL 40 mm PANELS

Pannelli Industrial spessore 40 mm - Appendimento a "baffle" e supporti per aggancio pannelli Industrial ai profili. Ogni pannello necessita di una coppia di supporti.
 40 mm thick Industrial panels - Baffle hangers and supports for attaching Industrial panels to profiles. Each panel requires a pair of supports.
 Panneaux Industrial de 40 mm d'épaisseur - Supports et suspensions pour fixer les panneaux Industrial aux profilés. Chaque panneau nécessite d'une paire de supports.
 Paneles Industrial de 40 mm de grosor - Colgadores y soportes para fijar los paneles Industrial a los perfiles. Cada panel requiere un par de soportes.
 40 mm dicke Industrial Paneele - Aufhängung und Einhängehalterungen für die Befestigung von Industrial-Paneelen an Profilen. Jedes Paneel benötigt ein Paar Halterungen.

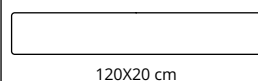
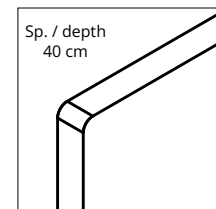

120X20 cm

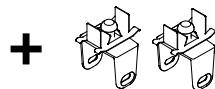
Bianco
White
7IN122/8-B
 Scatola da 8 pz.
 Box of 8 pcs.

1 code 7KGIN40/16-N
 Nero
 Black
8 coppie
8 pairs**o / or 1 code 7KGIN40/16-AL**Alluminio
Aluminium8 coppie
8 pairs

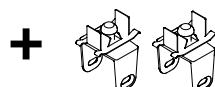
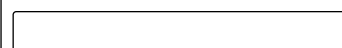
120X80 cm

Bianco
White
7IN128/4-B
 Scatola da 4 pz.
 Box of 4 pcs.

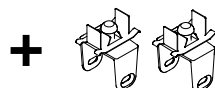
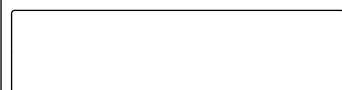
1 code 7KGIN40/8-N
 Nero
 Black
4 coppie
4 pairs**o / or 1 code 7KGIN40/8-AL**Alluminio
Aluminium4 coppie
4 pairs

160X20 cm

Bianco
White
7IN162/8-B
 Scatola da 8 pz.
 Box of 8 pcs.

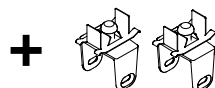
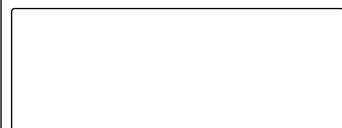
1 code 7KGIN40/16-N
 Nero
 Black
8 coppie
8 pairs**o / or 1 code 7KGIN40/16-AL**Alluminio
Aluminium8 coppie
8 pairs

160X40 cm

Bianco
White
7IN164/4-B
 Scatola da 4 pz.
 Box of 4 pcs.

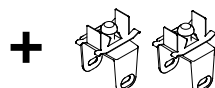
1 code 7KGIN40/8-N
 Nero
 Black
4 coppie
4 pairs**o / or 1 code 7KGIN40/8-AL**Alluminio
Aluminium4 coppie
4 pairs

160X60 cm

Bianco
White
7IN166/4-B
 Scatola da 4 pz.
 Box of 4 pcs.

1 code 7KGIN40/8-N
 Nero
 Black
4 coppie
4 pairs**o / or 1 code 7KGIN40/8-AL**Alluminio
Aluminium4 coppie
4 pairs

Per effettuare l'ordine: 1) indicare il codice del pannello 2) indicare la scelta dei supporti

To place the order: 1) select panel code 2) select supports

Pour passer la commande : 1) indiquer le code du panneau 2) indiquer le choix des supports

Para realizar el pedido: 1) indique el código del panel 2) indique la elección de soportes

Um das zu bestellen: 1) den Code des Paneels angeben 2) die Halterungen angeben

Pannelli Industrial spessore 40 mm - Appendimento a "baffle" e supporti per aggancio pannelli Industrial ai profili. Ogni pannello necessita di una coppia di supporti.

40 mm thick Industrial panels - Baffle hangers and supports for attaching Industrial panels to profiles. Each panel requires a pair of supports.

Panneaux Industrial de 40 mm d'épaisseur - Supports et suspensions pour fixer les panneaux Industrial aux profilés. Chaque panneau nécessite d'une paire de supports.

Paneles Industrial de 40 mm de grosor - Colgadores y soportes para fijar los paneles Industrial a los perfiles. Cada panel requiere un par de soportes.

40 mm dicke Industrial Paneele - Aufhängung und Einhängelhalterungen für die Befestigung von Industrial-Paneelen an Profilen. Jedes Paneel benötigt ein Paar Halterungen.

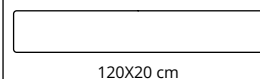
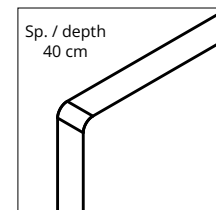

120X20 cm

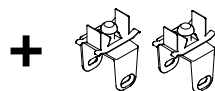
**7IN122/8-N**Scatola da 8 pz.
Box of 8 pcs.**1 code 7KGIN40/16-N**Nero
Black8 coppie
8 pairs**o / or 1 code 7KGIN40/16-AL**Alluminio
Aluminium8 coppie
8 pairs

120X80 cm

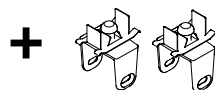
**7IN128/4-N**Scatola da 4 pz.
Box of 4 pcs.**1 code 7KGIN40/8-N**Nero
Black4 coppie
4 pairs**o / or 1 code 7KGIN40/8-AL**Alluminio
Aluminium4 coppie
4 pairs

160X20 cm

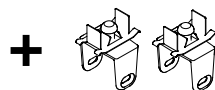
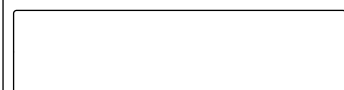
**7IN162/8-N**Scatola da 8 pz.
Box of 8 pcs.**1 code 7KGIN40/16-N**Nero
Black8 coppie
8 pairs**o / or 1 code 7KGIN40/16-AL**Alluminio
Aluminium8 coppie
8 pairs

160X40 cm

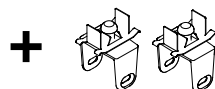
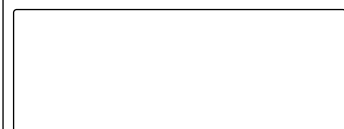
**7IN164/4-N**Scatola da 4 pz.
Box of 4 pcs.**1 code 7KGIN40/8-N**Nero
Black4 coppie
4 pairs**o / or 1 code 7KGIN40/8-AL**Alluminio
Aluminium4 coppie
4 pairs

160X60 cm

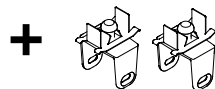
**7IN166/4-N**Scatola da 4 pz.
Box of 4 pcs.**1 code 7KGIN40/8-N**Nero
Black4 coppie
4 pairs**o / or 1 code 7KGIN40/8-AL**Alluminio
Aluminium4 coppie
4 pairs

Per effettuare l'ordine: 1) indicare il codice del pannello 2) indicare la scelta dei supporti

To place the order: 1) select panel code 2) select supports

Pour passer la commande : 1) indiquer le code du panneau 2) indiquer le choix des supports

Para realizar el pedido: 1) indique el código del panel 2) indique la elección de soportes

Um das zu bestellen: 1) den Code des Paneels angeben 2) die Halterungen angeben

Pannelli Snowsound - Appendimento a "baffle" e supporti per aggancio pannelli Snowsound ai profili. Ogni pannello necessita di una coppia di supporti.
 Snowsound panels - Baffle hangers and supports for attaching Snowsound panels to profiles. Each panel requires a pair of supports.
 Panneaux Snowsound - Supports et suspensions pour fixer les panneaux Snowsound aux profilés. Chaque panneau nécessite d'une paire de supports.
 Paneles Snowsound - Colgadores y soportes para fijar los paneles Snowsound a los perfiles. Cada panel requiere un par de soportes.
 Snowsound Paneele - Aufhängung und Einhängehalterungen für die Befestigung von Snowsound-Paneelen an Profilen. Jedes Paneel benötigt ein Paar Halterungen.

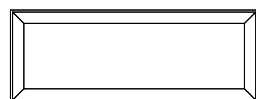

119x44 cm

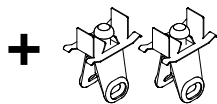
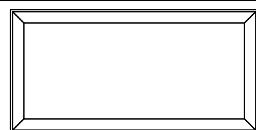
7KS412-XXXX1 pezzo
1 piece**1 code 7KGSB/2-N**Nero
Black1 coppia
1 pair**0 / OR 1 code 7KGSB/2-AL**Alluminio
Aluminium1 coppia
1 pair

119x59 cm

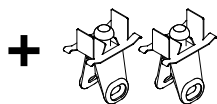
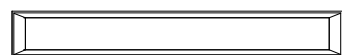
7KS126-XXXX1 pezzo
1 piece**1 code 7KGSB/2-N**Nero
Black1 coppia
1 pair**0 / OR 1 code 7KGSB/2-AL**Alluminio
Aluminium1 coppia
1 pair

159x22 cm

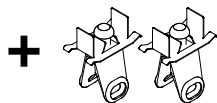
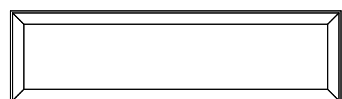
7KS216-XXXX1 pezzo
1 piece**1 code 7KGSB/2-N**Nero
Black1 coppia
1 pair**0 / OR 1 code 7KGSB/2-AL**Alluminio
Aluminium1 coppia
1 pair**SOLO/ONLY****0001 8007**

159x44 cm

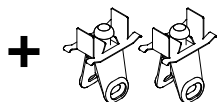
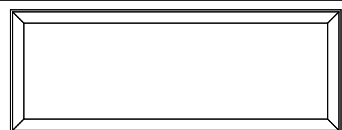
7KS416-XXXX1 pezzo
1 piece**1 code 7KGSB/2-N**Nero
Black1 coppia
1 pair**0 / OR 1 code 7KGSB/2-AL**Alluminio
Aluminium1 coppia
1 pair

159x59 cm

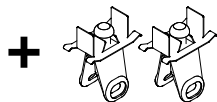
7KS166-XXXX1 pezzo
1 piece**1 code 7KGSB/2-N**Nero
Black1 coppia
1 pair**0 / OR 1 code 7KGSB/2-AL**Alluminio
Aluminium1 coppia
1 pair

Per effettuare l'ordine: 1) indicare il codice del pannello 2) indicare la scelta del colore del pannello 3) indicare la scelta dei supporti (7KGSB/2-N o 7KGSB/2-AL)

To place order: 1) select panel code 2) select panel colour 3) select supports (7KGSB/2-N o 7KGSB/2-AL)

Pour passer la commande : 1) indiquer le code du panneau 2) indiquer le choix de la couleur du panneau 3) indiquer le choix des supports (7KGSB/2-N o 7KGSB/2-AL)

Para realizar el pedido: 1) indique el código del panel 2) indique el color del panel elegido 3) indique la elección de soportes (7KGSB/2-N o 7KGSB/2-AL)

Um das zu bestellen: 1) den Code des Paneels angeben 2) die Farbe des Panels angeben 3) die Halterungen angeben (7KGSB/2-N o 7KGSB/2-AL)

Colori disponibili dei pannelli / Panels available colors



0001



8004



8007



1008

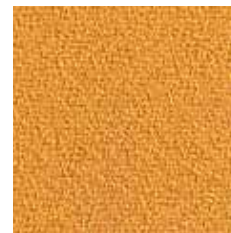

3008

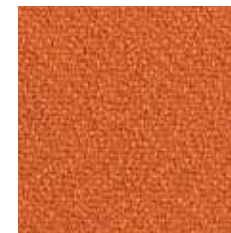

4030



4027



7004



6046



6075



8002



8033

Pannelli in tessuto Snowsound Fiber 2 Line - Appendimento a "baffle" e supporti per aggancio pannelli Snowsound Fiber 2 Line ai profili. Ogni pannello necessita di una coppia di supporti.
Snowsound Fiber 2 Line fabric panels - Baffle hangers and supports for attaching Snowsound Fiber 2 Line panels to profiles. Each panel requires a pair of supports.
Panneaux de tissu Snowsound Fiber 2 Line - Supports et suspensions pour fixer les panneaux Snowsound Fiber 2 Line aux profilés. Chaque panneau nécessite d'une paire de supports.
Paneles de tejido Snowsound Fiber 2 Line - Colgadores y soportes para fijar los paneles Snowsound Fiber 2 Line a los perfiles. Cada panel requiere un par de soportes.
Snowsound Fiber 2 Line Stoffbahnen - Aufhängung und Einhängehalterungen für die Befestigung von Snowsound Fiber 2 Line-Paneeelen an Profilen. Jedes Paneel benötigt ein Paar Halterungen.

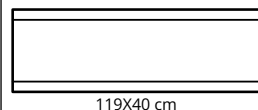

119X40 cm

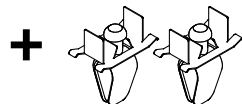
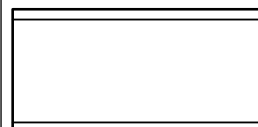
7K12040TT-XXXScatola da 2 pz.
Box of 2 pcs.**1 code 7KGTES/4-N**Nero
Black2 coppie
2 pairs**o / or 1 code 7KGTES/4-AL**Alluminio
Aluminium2 coppie
2 pairs

119X60 cm

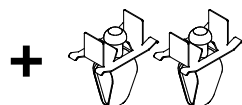
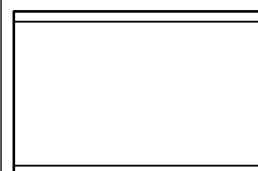
7K12060TT-XXXScatola da 2 pz.
Box of 2 pcs.**1 code 7KGTES/4-N**Nero
Black2 coppie
2 pairs**o / or 1 code 7KGTES/4-AL**Alluminio
Aluminium2 coppie
2 pairs

119X80 cm

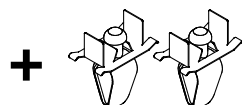
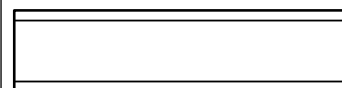
7K12080TT-XXXScatola da 2 pz.
Box of 2 pcs.**1 code 7KGTES/4-N**Nero
Black2 coppie
2 pairs**o / or 1 code 7KGTES/4-AL**Alluminio
Aluminium2 coppie
2 pairs

159X40 cm

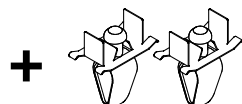
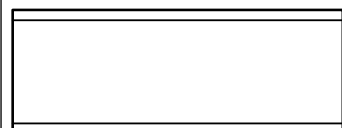
7K16040TT-XXXScatola da 2 pz.
Box of 2 pcs.**1 code 7KGTES/4-N**Nero
Black2 coppie
2 pairs**o / or 1 code 7KGTES/4-AL**Alluminio
Aluminium2 coppie
2 pairs

159X60 cm

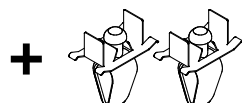
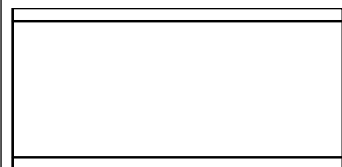
7K16060TT-XXXScatola da 2 pz.
Box of 2 pcs.**1 code 7KGTES/4-N**Nero
Black2 coppie
2 pairs**o / or 1 code 7KGTES/4-AL**Alluminio
Aluminium2 coppie
2 pairs

159X80 cm

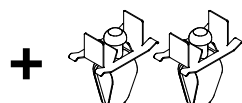
7K16080TT-XXXScatola da 2 pz.
Box of 2 pcs.**1 code 7KGTES/4-N**Nero
Black2 coppie
2 pairs**o / or 1 code 7KGTES/4-AL**Alluminio
Aluminium2 coppie
2 pairs

Per effettuare l'ordine: 1) indicare il codice del pannello 2) indicare la scelta del colore del pannello 3) indicare la scelta dei supporti (7KGTES/4-N o 7KGTES/4-AL)

To place order: 1) select panel code 2) select panel colour 3) select supports (7KGTES/4-N o 7KGTES/4-AL)

Pour passer la commande : 1) indiquer le code du panneau 2) indiquer le choix de la couleur du panneau 3) indiquer le choix des supports (7KGTES/4-N o 7KGTES/4-AL)

Para realizar el pedido: 1) indique el código del panel 2) indique el color del panel elegido 3) indique la elección de soportes (7KGTES/4-N o 7KGTES/4-AL)

Um das zu bestellen: 1) den Code des Paneels angeben 2) die Farbe des Panels angeben 3) die Halterungen angeben (7KGTES/4-N o 7KGTES/4-AL)

Colori disponibili dei pannelli / Panels available colors



200



201



202



203

Pannelli in tessuto Snowsound Fiber 3 Melange - Appendimento a "baffle" e supporti per aggancio pannelli Snowsound Fiber 3 Melange ai profili. Ogni pannello necessita di una coppia di supporti.
Snowsound Fiber 3 Melange fabric panels - Baffle hangers and supports for attaching Snowsound Fiber 3 Melange panels to profiles. Each panel requires a pair of supports.
Panneaux de tissu Snowsound Fiber 3 Melange - Supports et suspensions pour fixer les panneaux Snowsound Fiber 3 Melange aux profilés. Chaque panneau nécessite d'une paire de supports.
Paneles de tejido Snowsound Fiber 3 Melange - Colgadores y soportes para fijar los paneles Snowsound Fiber 3 Melange a los perfiles. Cada panel requiere un par de soportes.
Snowsound Fiber 3 Melange Stoffbahnen - Aufhängung und Einhängelhalterungen für die Befestigung von Snowsound Fiber 3 Melange-Paneelen an Profilen. Jedes Paneel benötigt ein Paar Halterungen.

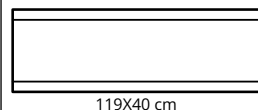

119X40 cm

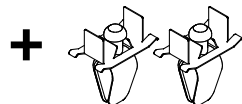
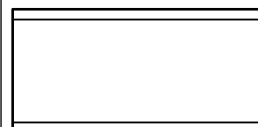
7K12040TT-XXXScatola da 2 pz.
Box of 2 pcs.**1 code 7KGTES/4-N**Nero
Black2 coppie
2 pairs**o / or 1 code 7KGTES/4-AL**Alluminio
Aluminium2 coppie
2 pairs

119X60 cm

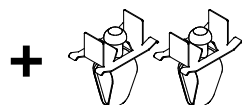
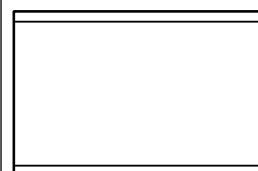
7K12060TT-XXXScatola da 2 pz.
Box of 2 pcs.**1 code 7KGTES/4-N**Nero
Black2 coppie
2 pairs**o / or 1 code 7KGTES/4-AL**Alluminio
Aluminium2 coppie
2 pairs

119X80 cm

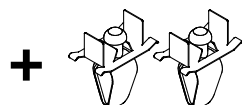
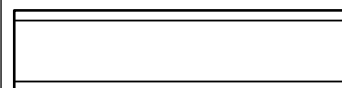
7K12080TT-XXXScatola da 2 pz.
Box of 2 pcs.**1 code 7KGTES/4-N**Nero
Black2 coppie
2 pairs**o / or 1 code 7KGTES/4-AL**Alluminio
Aluminium2 coppie
2 pairs

159X40 cm

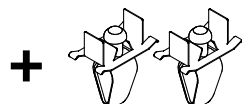
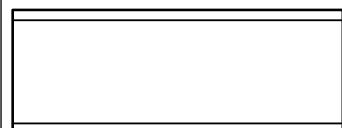
7K16040TT-XXXScatola da 2 pz.
Box of 2 pcs.**1 code 7KGTES/4-N**Nero
Black2 coppie
2 pairs**o / or 1 code 7KGTES/4-AL**Alluminio
Aluminium2 coppie
2 pairs

159X60 cm

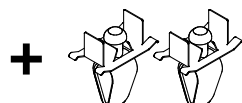
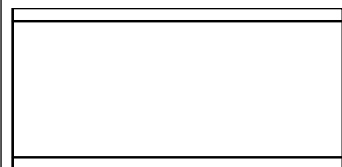
7K16060TT-XXXScatola da 2 pz.
Box of 2 pcs.**1 code 7KGTES/4-N**Nero
Black2 coppie
2 pairs**o / or 1 code 7KGTES/4-AL**Alluminio
Aluminium2 coppie
2 pairs

159X80 cm

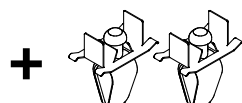
7K16080TT-XXXScatola da 2 pz.
Box of 2 pcs.**1 code 7KGTES/4-N**Nero
Black2 coppie
2 pairs**o / or 1 code 7KGTES/4-AL**Alluminio
Aluminium2 coppie
2 pairs

Per effettuare l'ordine: 1) indicare il codice del pannello 2) indicare la scelta del colore del pannello 3) indicare la scelta dei supporti (7KGTES/4-N o 7KGTES/4-AL)

To place order: 1) select panel code 2) select panel colour 3) select supports (7KGTES/4-N o 7KGTES/4-AL)

Pour passer la commande : 1) indiquer le code du panneau 2) indiquer le choix de la couleur du panneau 3) indiquer le choix des supports (7KGTES/4-N o 7KGTES/4-AL)

Para realizar el pedido: 1) indique el código del panel 2) indique el color del panel elegido 3) indique la elección de soportes (7KGTES/4-N o 7KGTES/4-AL)

Um das zu bestellen: 1) den Code des Paneels angeben 2) die Farbe des Panels angeben 3) die Halterungen angeben (7KGTES/4-N o 7KGTES/4-AL)

Colori disponibili dei pannelli / Panels available colors

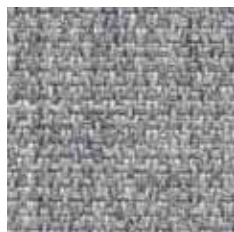

300

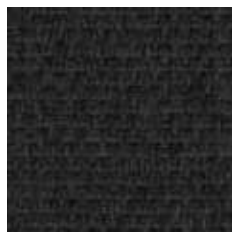

302



303

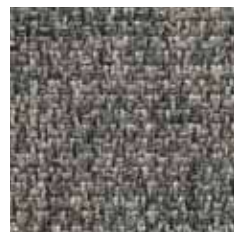

304

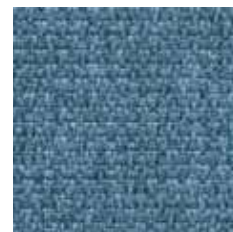

305



308

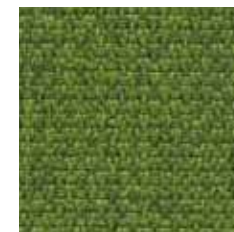

309



311

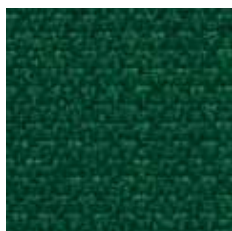

313



314

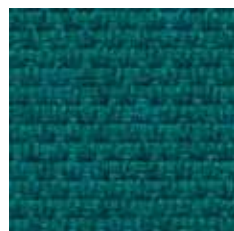

315



316

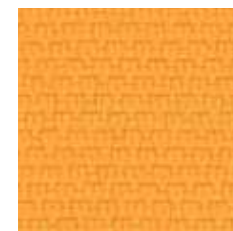

317

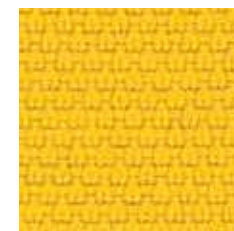

318

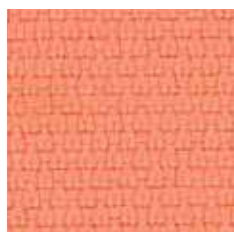

319



320

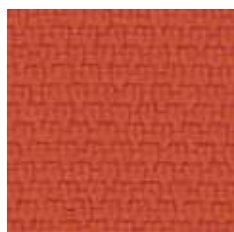

321

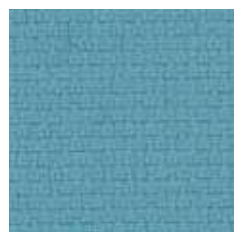

322

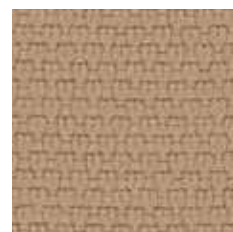

323

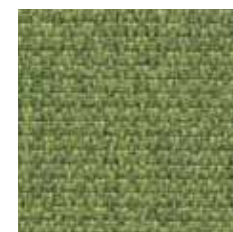

324



325

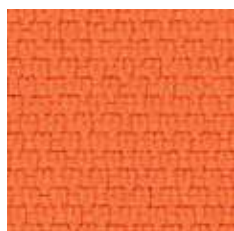

326



327

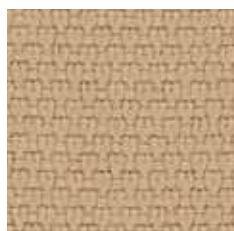

328

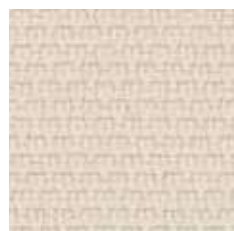

329



330

COMPONENTI PER ATTACCO DIRETTO A SOFFITTO / COMPONENTS FOR DIRECT CEILING CONNECTION / COMPOSANTS POUR CONNEXION DIRECTE AU PLAFOND / COMPONENTES PARA CONEXIÓN DIRECTA AL TECHO / KOMPONENTEN FÜR DEN DIREKTEN DECKENANSCHLUSS

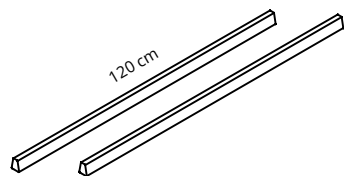

7K120P/2-AL

Alluminio
Aluminium
Aluminium
Aluminio
Aluminium

1 coppia / 1 pair
1 paire / 1 pare
1 Paar

2 Profili in alluminio L. 120 cm

2 Aluminium profiles L. 120 cm

2 Profils en aluminium L. 120 cm

2 Perfiles de aluminio L. 120 cm

7K120P/2-N

Nero
Black
Noir
Negro
Schwarz

1 coppia / 1 pair
1 paire / 1 pare
1 Paar

2 Aluminium-Profile L. 120 cm

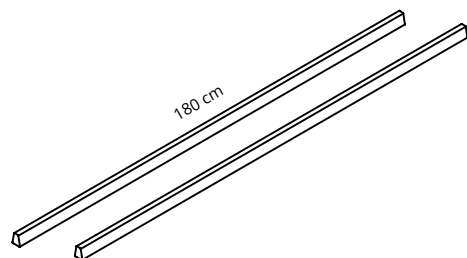

7K180P/2-AL

Alluminio
Aluminium
Aluminium
Aluminio
Aluminium

1 coppia / 1 pair
1 paire / 1 pare
1 Paar

2 Profili in alluminio L. 180 cm

2 Aluminium profiles L. 180 cm

2 Profils en aluminium L. 180 cm

2 Perfiles de aluminio L. 180 cm

7K180P/2-N

Nero
Black
Noir
Negro
Schwarz

1 coppia / 1 pair
1 paire / 1 pare
1 Paar

2 Aluminium-Profile L. 180 cm

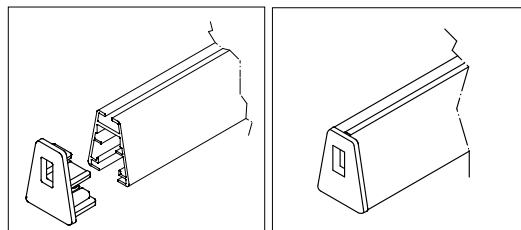
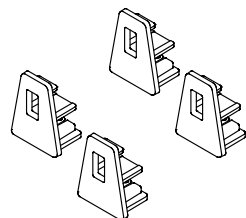

7KTAP/4-AL

Alluminio
Aluminium
Aluminium
Aluminio
Aluminium

4 pz / 4 pcs

4 tappi terminali per profili **7K120P/2-XX / 7K180P/2-XX**. Ogni profilo necessita di 2 tappi.

4 end caps for **7K120P/2-XX / 7K180P/2-XX** profiles. Each profile requires 2 end caps.

4 embouts pour les profils **7K120P/2-XX / 7K180P/2-XX**. Chaque profil nécessite de 2 embouts.

4 tapas para perfiles **7K120P/2-XX / 7K180P/2-XX**. Cada perfil requiere 2 tapas de extremo.

4 Endkappen für **7K120P/2-XX / 7K180P/2-XX** Profile. Jedes Profil benötigt 2 Endkappen.

7KTAP/4-N

Nero
Black
Noir
Negro
Schwarz

4 pz / 4 pcs

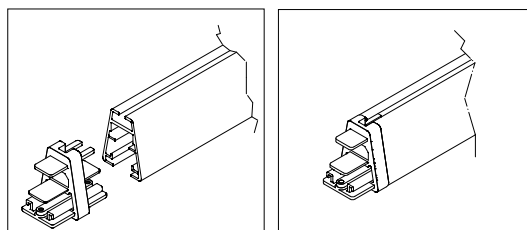
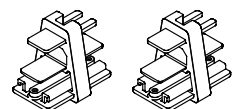

7KGT/2-AL

Alluminio
Aluminium
Aluminium
Aluminio
Aluminium

1 coppia / 1 pair
1 paire / 1 pare
1 Paar

2 giunti di collegamento in linea per profili **7K120P/2-XX / 7K180P/2-XX**.

2 in-line connecting joints for **7K120P/2-XX / 7K180P/2-XX** profiles

2 joints de raccordement en ligne pour les profils

7K120P/2-XX / 7K180P/2-XX

2 juntas de conexión en línea para perfiles **7K120P/2-XX / 7K180P/2-XX**.

7KGT/2-N

Nero
Black
Noir
Negro
Schwarz

1 coppia / 1 pair
1 paire / 1 pare
1 Paar

2 Inline-Verbindungsstücke für **7K120P/2-XX / 7K180P/2-XX** Profile.

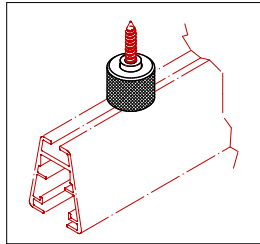
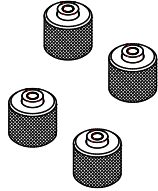
COMPONENTI PER ATTACCO DIRETTO A SOFFITTO / COMPONENTS FOR DIRECT CEILING CONNECTION / COMPOSANTS POUR CONNEXION DIRECTE AU PLAFOND / COMPONENTES PARA CONEXIÓN DIRECTA AL TECHO / KOMPONENTEN FÜR DEN DIREKTEN DECKENANSCHLUSS**7KAD/4-NI**

4 pz / 4 pcs

4 attacchi diretti a soffitto per profili **7K120P/2-XX** / **7K180P/2-XX**. Ogni profilo necessita di 2 attacchi.

4 direct ceiling connections for **7K120P/2-XX** / **7K180P/2-XX** profiles. Each profile requires 2 connections.

4 connexions directes au plafond pour les profils **7K120P/2-XX** / **7K180P/2-XX**. Chaque profil nécessite de 2 connexions.

4 conexiones directas al techo para perfiles **7K120P/2-XX** / **7K180P/2-XX**. Cada perfil requiere 2 conexiones.

4 direkte Deckenanschlüsse für die Profile **7K120P/2-XX** / **7K180P/2-XX**. Jedes Profil benötigt 2 Anschlüsse.

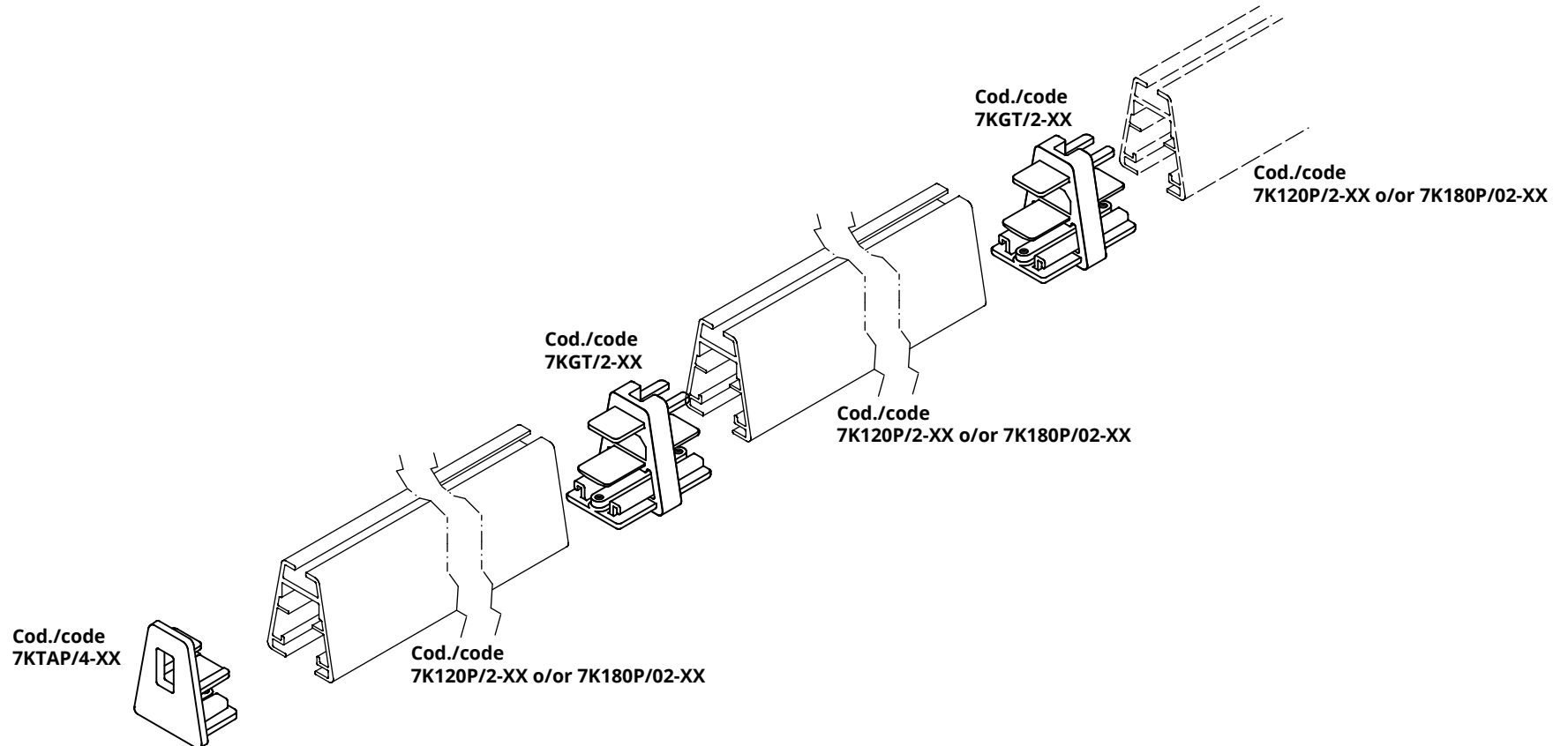
Schema utilizzo tappi terminali e giunti di collegamento sui profili - Diagram for end caps and profile connection joints - Schéma d'utilisation des embouts et des joints de raccordement sur les profils - Esquema de utilización de las tapas y uniones de perfiles - Schema mit Endkappen und Profilverbindungsstücken

COMPONENTI PER ATTACCO A SOFFITTO SU CAVI / COMPONENTS FOR CEILING ATTACHMENT ON CABLES / COMPOSANTS POUR LA FIXATION AU PLAFOND SUR LES CÂBLES / COMPONENTES PARA LA FIJACIÓN DE CABLES AL TECHO / KOMPONENTEN FÜR DIE DECKENBEFESTIGUNG AN KABELN

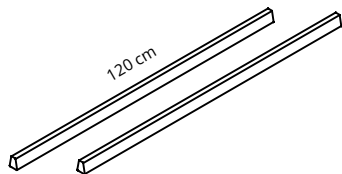

7K120P/2-AL

Alluminio
Aluminium
Aluminium
Aluminio
Aluminium

1 coppia / 1 pair
1 paire / 1 pare
1 Paar

2 Profili in alluminio L. 120 cm

2 Aluminium profiles L. 120 cm

2 Profils en aluminium L. 120 cm

2 Perfiles de aluminio L. 120 cm

7K120P/2-N

Nero
Black
Noir
Negro
Schwarz

1 coppia / 1 pair
1 paire / 1 pare
1 Paar

2 Aluminium-Profile L. 120 cm

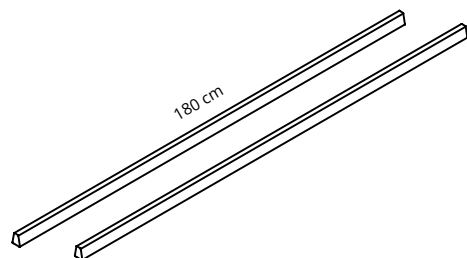

7K180P/2-AL

Alluminio
Aluminium
Aluminium
Aluminio
Aluminium

1 coppia / 1 pair
1 paire / 1 pare
1 Paar

2 Profili in alluminio L. 180 cm

2 Aluminium profiles L. 180 cm

2 Profils en aluminium L. 180 cm

2 Perfiles de aluminio L. 180 cm

7K180P/2-N

Nero
Black
Noir
Negro
Schwarz

1 coppia / 1 pair
1 paire / 1 pare
1 Paar

2 Aluminium-Profile L. 180 cm

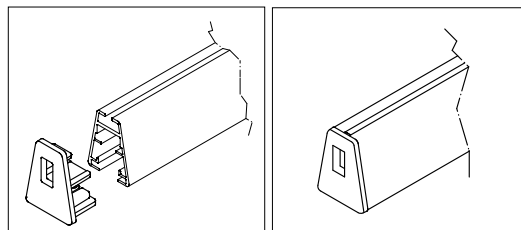
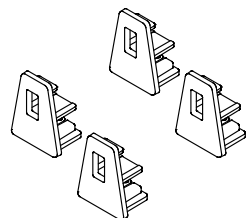

7KTAP/4-AL

Alluminio
Aluminium
Aluminium
Aluminio
Aluminium

4 pz / 4 pcs

4 tappi terminali per profili **7K120P/2-XX / 7K180P/2-XX**. Ogni profilo necessita di 2 tappi.

4 end caps for **7K120P/2-XX / 7K180P/2-XX** profiles. Each profile requires 2 end caps.

4 embouts pour les profils **7K120P/2-XX / 7K180P/2-XX**. Chaque profil nécessite de 2 embouts.

4 tapas para perfiles **7K120P/2-XX / 7K180P/2-XX**. Cada perfil requiere 2 tapas de extremo.

4 Endkappen für **7K120P/2-XX / 7K180P/2-XX** Profile. Jedes Profil benötigt 2 Endkappen.

7KTAP/4-N

Nero
Black
Noir
Negro
Schwarz

4 pz / 4 pcs

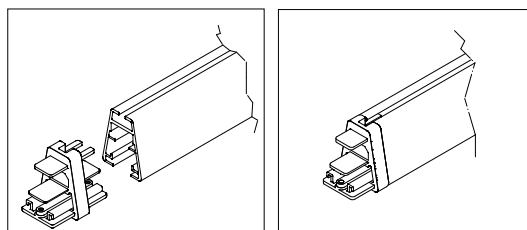
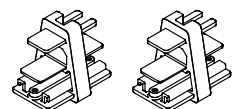

7KGTG/2-AL

Alluminio
Aluminium
Aluminium
Aluminio
Aluminium

1 coppia / 1 pair
1 paire / 1 pare
1 Paar

2 giunti di collegamento in linea per profili **7K120P/2-XX / 7K180P/2-XX**.

2 in-line connecting joints for **7K120P/2-XX / 7K180P/2-XX** profiles

2 joints de raccordement en ligne pour les profils

7K120P/2-XX / 7K180P/2-XX

2 juntas de conexión en línea para perfiles **7K120P/2-XX / 7K180P/2-XX**.

7KGTG/2-N

Nero
Black
Noir
Negro
Schwarz

1 coppia / 1 pair
1 paire / 1 pare
1 Paar

2 In-line-Verbindungsstücke für **7K120P/2-XX / 7K180P/2-XX** Profile.

COMPONENTI PER ATTACCO A SOFFITTO SU CAVI / COMPONENTS FOR CEILING ATTACHMENT ON CABLES / COMPOSANTS POUR LA FIXATION AU PLAFOND SUR LES CÂBLES / COMPONENTES PARA LA FIJACIÓN DE CABLES AL TECHO / KOMPONENTEN FÜR DIE DECKENBEFESTIGUNG AN KABELN

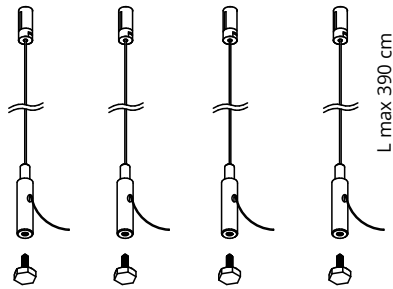

7KAC/4-NI

4 pz / 4 pcs

4 attacchi a soffitto con cavi per profili **7K120P/2-XX / 7K120P/2-XX**. Ogni profilo necessita di 2 attacchi.
 4 ceiling connections with cables for **7K120P/2-XX / 7K180P/2-XX** profiles. Each profile requires 2 connections.
 4 connexions au plafond avec câbles pour les profils **7K120P/2-XX / 7K180P/2-XX**. Chaque profil nécessite de 2 connexions.
 4 conexiones de techo con cables para perfiles **7K120P/2-XX / 7K180P/2-XX**. Cada perfil requiere 2 conexiones.
 4 Deckenanschlüsse mit Kabeln für die Profile **7K120P/2-XX / 7K180P/2-XX**. Jedes Profil benötigt 2 Anschlüsse.

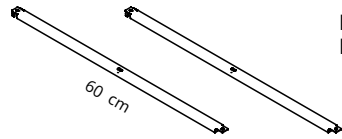

**PER PANNELLI 119/120
 DETTAGLIO UTILIZZO TRA LE STRUTTURE ALLA PAGINE
 SEGUENTE**

FOR PANELS 119/120. DETAILS OF USE BETWEEN STRUCTURES ON THE FOLLOWING PAGES

7K60D/2-AL

Alluminio
 Aluminium
 Aluminium
 Aluminio
 Aluminium

1 coppia / 1 pair
 1 paire / 1 pare
 1 Paar

2 Distanziali in acciaio L. 60 cm
 2 Steel spacers L. 60 cm
 2 Entretoises en acier L. 60 cm
 2 Distanciadores de acero L. 60 cm

7K60D/2-N

Nero
 Black
 Noir
 Negro
 Schwarz

1 coppia / 1 pair
 1 paire / 1 pare
 1 Paar

2 Stahl-Abstandshalter L. 60 cm

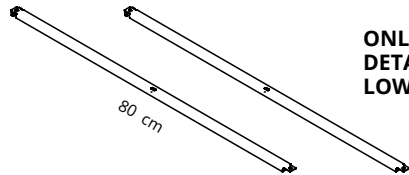

**SOLO DISTANZIALE
 DETTAGLIO UTILIZZO TRA LE STRUTTURE ALLA PAGINE
 SEGUENTE**

**ONLY SPACER.
 DETAILS OF USE BETWEEN STRUCTURES ON THE FOLLOWING PAGES**

7K80D/2-AL

Alluminio
 Aluminium
 Aluminium
 Aluminio
 Aluminium

1 coppia / 1 pair
 1 paire / 1 pare
 1 Paar

2 Distanziali in acciaio L. 80 cm
 2 Steel spacers L. 80 cm
 2 Entretoises en acier L. 80 cm
 2 Distanciadores de acero L. 80 cm

7K80D/2-N

Nero
 Black
 Noir
 Negro
 Schwarz

1 coppia / 1 pair
 1 paire / 1 pare
 1 Paar

2 Stahl-Abstandshalter L. 80 cm

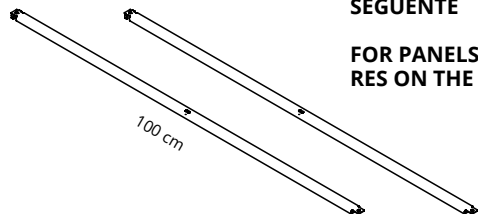

**PER PANNELLI 159/160
 DETTAGLIO UTILIZZO TRA LE STRUTTURE ALLA PAGINE
 SEGUENTE**

FOR PANELS 159/160. DETAILS OF USE BETWEEN STRUCTURES ON THE FOLLOWING PAGES

7K100D/2-AL

Alluminio
 Aluminium
 Aluminium
 Aluminio
 Aluminium

1 coppia / 1 pair
 1 paire / 1 pare
 1 Paar

2 Distanziali in acciaio L. 100 cm
 2 Steel spacers L. 100 cm
 2 Entretoises en acier L. 100 cm
 2 Distanciadores de acero L. 100 cm

7K100D/2-N

Nero
 Black
 Noir
 Negro
 Schwarz

1 coppia / 1 pair
 1 paire / 1 pare
 1 Paar

2 Stahl-Abstandshalter L. 100 cm

UTILIZZO DISTANZIALI TRA LE STRUTTURE NELLE COMPOSIZIONI A SOFFITTO SU CAVI - USE OF SPACERS BETWEEN STRUCTURES IN CABLE CEILING COMPOSITIONS - UTILISATION D'ENTRETOISES ENTRE LES STRUCTURES POUR LES COMPOSITIONS AU PLAFONDS PAR CÂBLES - USO DE SEPARADORES ENTRE ESTRUCTURAS EN COMPOSICIONES DE TECHOS DE CABLES - VERWENDUNG VON ABSTANDSHALTERN ZWISCHEN DEN STRUKTUREN IN KABELDECKENKOMPOSITIONEN

INDUSTRIAL 24/40 MM PANELS

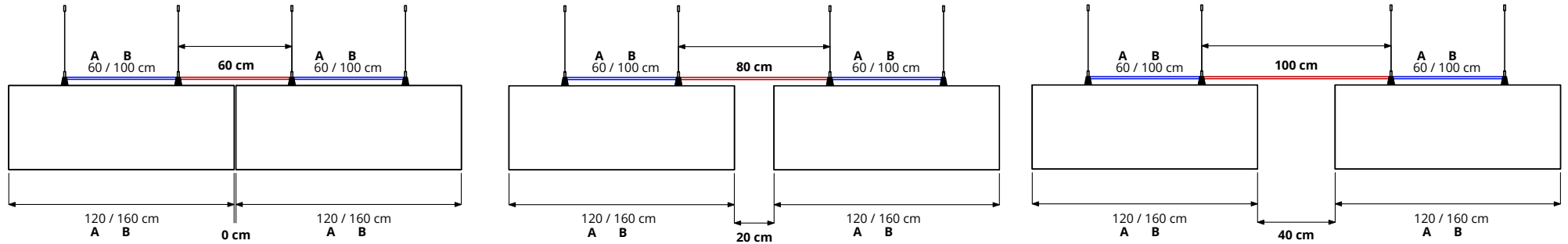

SNOWSOUND PANELS

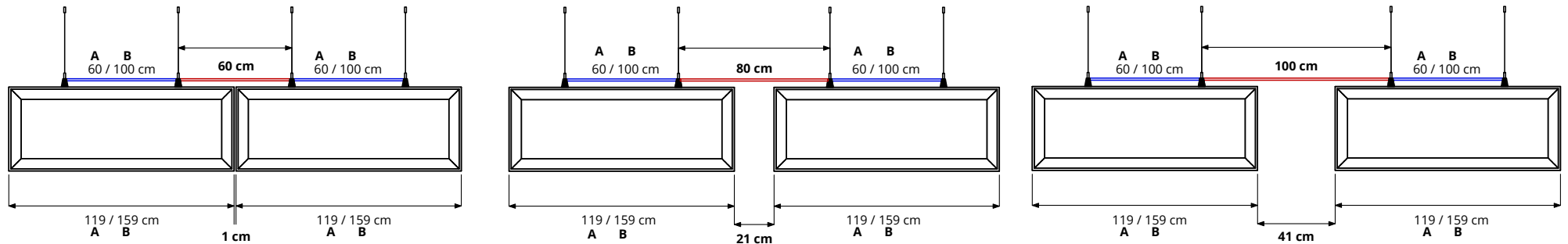

FIBER 2 LINE / FIBER 3 MELANGE PANELS

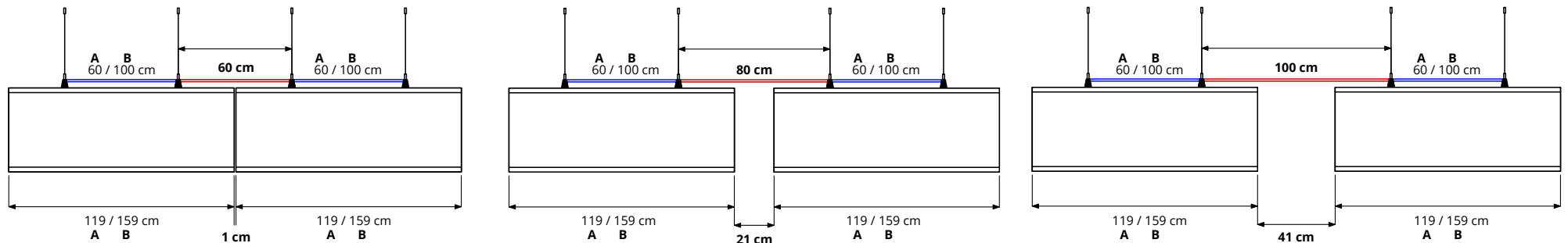

7KGAI/8

8 pz / 8 pcs

Giunto allineamento pannelli Industrial 24 mm e 40 mm. Da utilizzare per l'allineamento dei pannelli quando si intende non lasciare spazio tra un pannello e l'altro.

Panel alignment joint Industrial 24 mm and 40 mm. To be used for aligning panels when no gap is to be left between one panel and another.

Joint d'alignement de panneau Industriel 24 mm et 40 mm A utiliser pour aligner les panneaux lorsqu'aucun espace ne doit être laissé entre un panneau et un autre.

Junta de alineación de paneles Industrial 24 mm y 40 mm. Se utiliza para alinear paneles cuando no se desea dejar ningún hueco entre un panel y otro.

Ausrichtungsfuge Industrial 24 mm und 40 mm, zum Ausrichten von Paneelen, wenn keine Lücke zwischen den Paneelen bleiben soll.

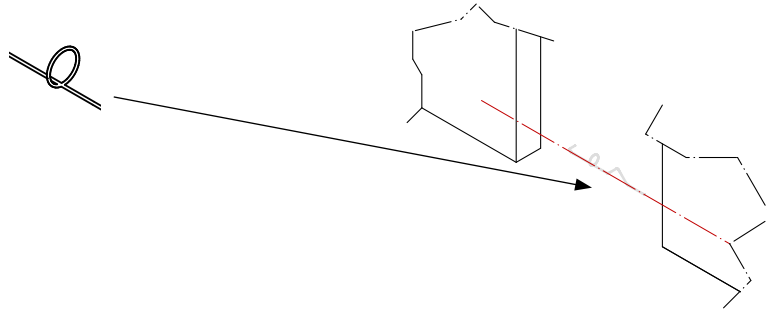

INDUSTRIAL 24/40 MM PANELS

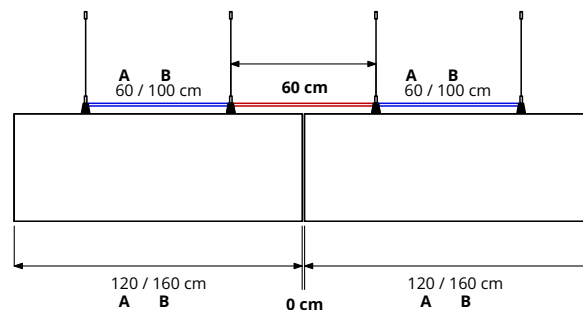









L'utilizzo dei giunti di collegamento 7KGAI/8 è consigliato in caso di queste configurazioni.

The use of connecting joints 7KGAI/8 is recommended in the case of these configurations.

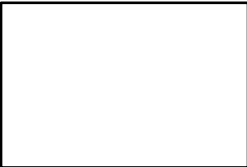
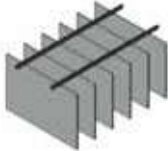
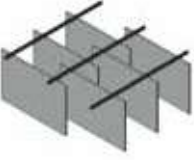
L'utilisation des joints de raccordement 7KGAI/8 est recommandée dans le cas de ces configurations.

Se recomienda el uso de las juntas de conexión 7KGAI/8 en el caso de estas configuraciones.

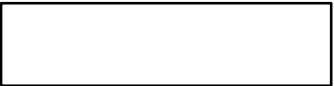
Bei diesen Konfigurationen wird die Verwendung der Verbindungsstücke 7KGAI/8 empfohlen.

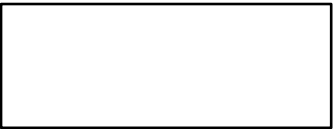
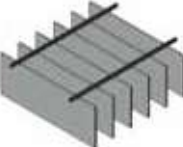
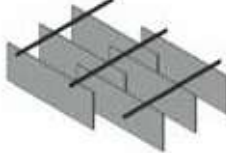
Pannello Panel Industrial 40 / Industrial 24	Dimensione cm Dimension cm Taille cm Tamaño cm Größe cm	n. max. pannelli per struttura: max. no. of panels per structure: nombre max. de panneaux par structure : n° máx. de paneles por estructura: max. Anzahl der Paneele pro Struktur: L. 120 / 180 cm	Struttura con 2 profili Structure with 2 profiles Structure à 2 profils Estructura con 2 perfiles Struktur mit 2 Profilen	Struttura con 3 profili Structure with 3 profiles Structure à 3 profils Estructura con 3 perfiles Struktur mit 3 Profilen
	20 x 120	12		
	80 x 120	6		
	20 x 160	12		
	40 x 160	8		
	60 x 160	6		











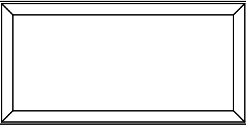

I pannelli si intendono uniformemente distribuiti sulla struttura. Pagina 72-73-74







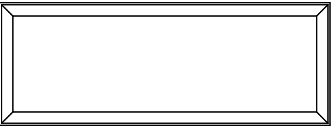
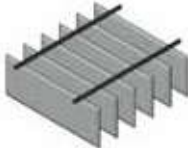



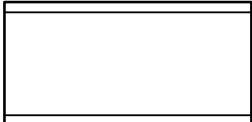

The panels are intended to be evenly distributed along the structure. Page 72-73-74

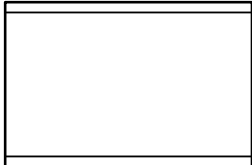
Les panneaux sont destinés à être répartis uniformément sur la structure. Page 72-73-74

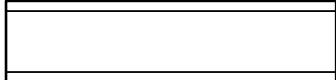
Los paneles se distribuyen uniformemente por la estructura. Página 72-73-74

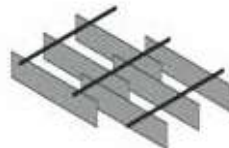
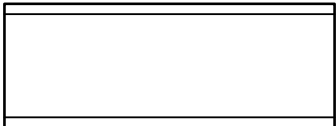
Die Paneele sollen gleichmäßig über die Struktur verteilt werden. Seite 72-73-74

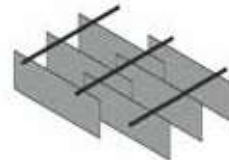
Pannello Panel Snowsound	Dimensione cm Dimension cm Taille cm Tamaño cm Größe cm	n. max. pannelli per struttura: max. no. of panels per structure: nombre max. de panneaux par structure : n° máx. de paneles por estructura: max. Anzahl der Paneele pro Struktur: L. 120 / 180 cm	Struttura con 2 profili Structure with 2 profiles Structure à 2 profils Estructura con 2 perfiles Struktur mit 2 Profilen	Struttura con 3 profili Structure with 3 profiles Structure à 3 profils Estructura con 3 perfiles Struktur mit 3 Profilen
	<p>44 x 119</p>	<p>6</p>		
	<p>59 x 119</p>	<p>6</p>		
	<p>22 x 159</p>	<p>12</p>		
	<p>44 x 159</p>	<p>6</p>		
	<p>59 x 159</p>	<p>6</p>		

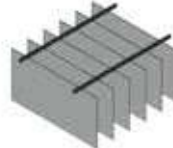
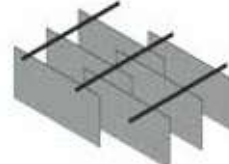
Pannello Panel Textile Fiber 2 / Fiber 3	Dimensione cm Dimension cm Taille cm Tamaño cm Größe cm	n. max. pannelli per struttura: max. no. of panels per structure: nombre max. de panneaux par structure : n° máx. de paneles por estructura: max. Anzahl der Paneele pro Struktur: L. 120 / 180 cm	Struttura con 2 profili Structure with 2 profiles Structure à 2 profils Estructura con 2 perfiles Struktur mit 2 Profilen	Struttura con 3 profili Structure with 3 profiles Structure à 3 profils Estructura con 3 perfiles Struktur mit 3 Profilen
	40 x 119	12		
	60 x 119	6		
	80 x 119	6		
	40 x 159	6		
	60 x 159	6		
	80 x 159	6		

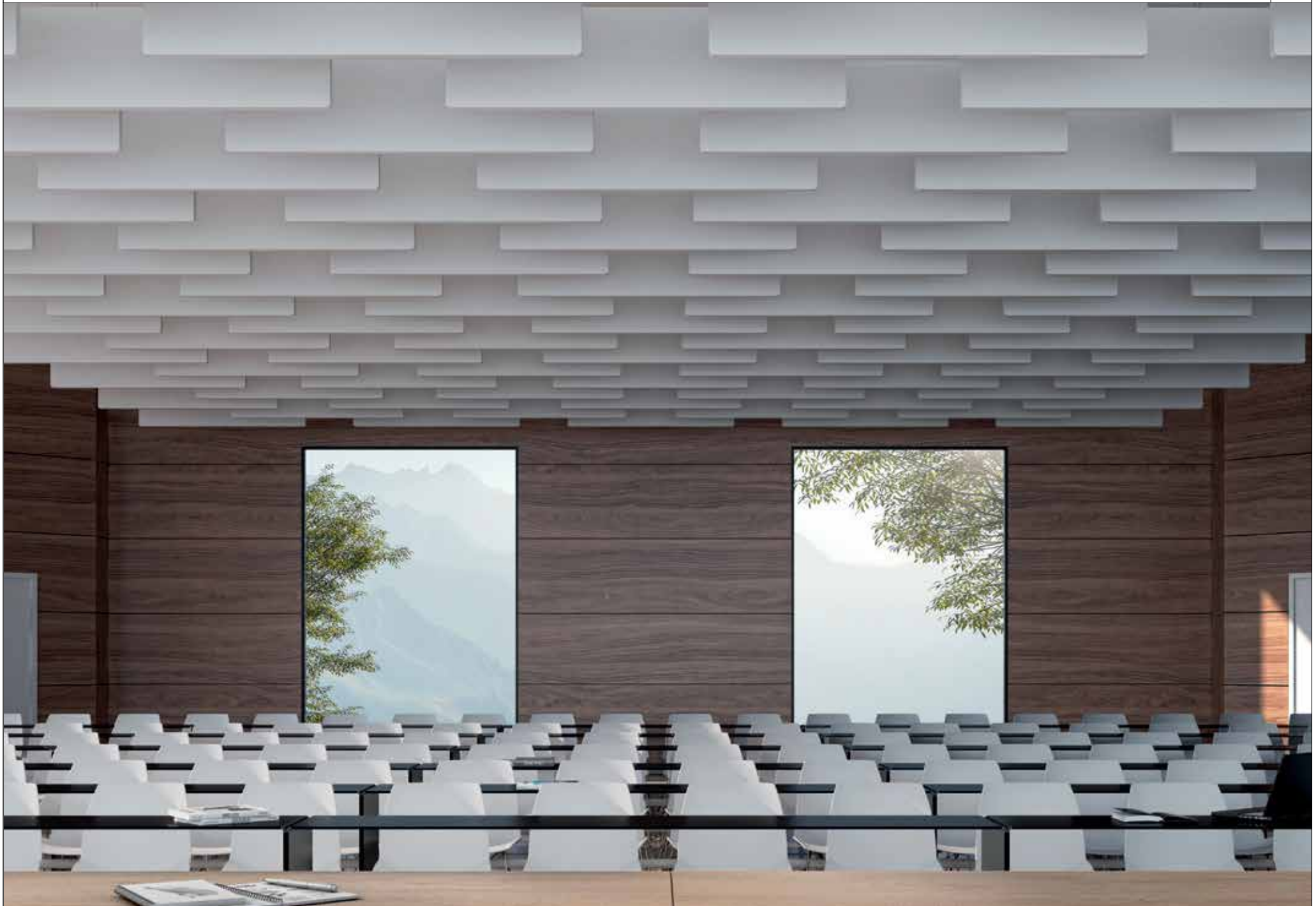

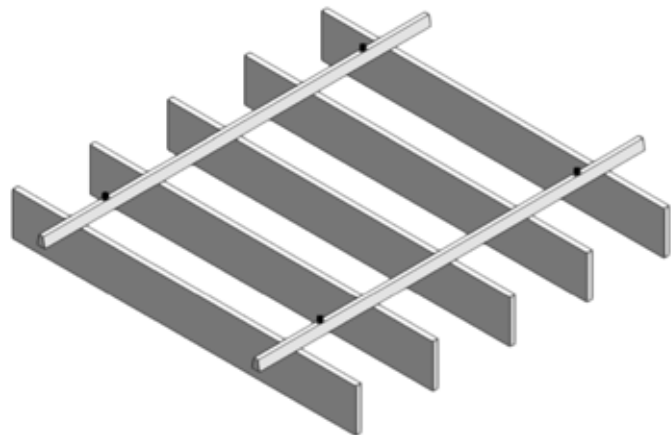
**MODULO BASE - BASE UNIT - STRUCTURE DE BASE - ESTRUCTURA BASICA - BASISSTRUKTUR**

1 struttura alluminio L. 180 cm 7KFRAME3-AL
5 pannelli Industrial 24 mm - dimensione 20x160 cm

1 aluminium frame L. 180 cm 7KFRAME3-AL
5 Industrial 24 mm panels - size 20x160 cm

1 structure en aluminium L. 180 cm 7KFRAME3-AL
5 panneaux Industrial 24 mm - taille 20x160 cm

1 estructura de aluminio L. 180 cm 7KFRAME3-AL
5 paneles Industrial 24 mm - dimensión 20x160 cm

1 Aluminiumstruktur L. 180 cm 7KFRAME3-AL
5 Paneele Industrial 24 mm - Format 20x160 cm

Superficie coperta 2,88 m²
Total area 2,88 m²
Surface couverte 2,88 m²
Superficie cubierta 2,88 m²
Überdachte Fläche 2,88 m²

Prezzo al m²
Preice per m²
Prix par m²
Precio por m²
Preis pro m²

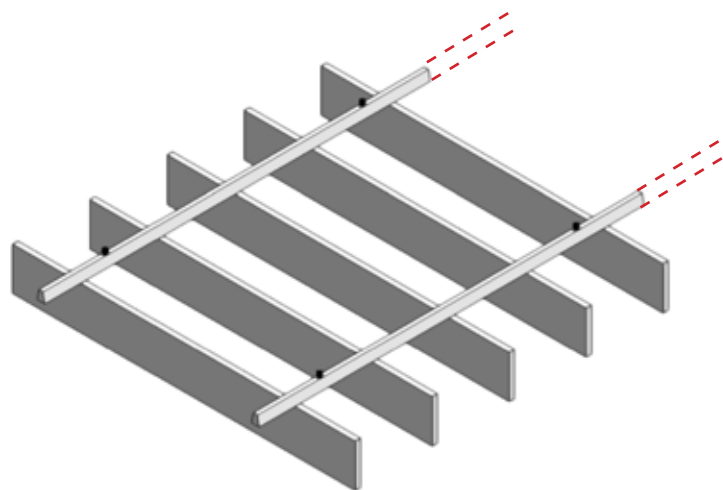
**MODULO SEGUITO - ADD-ON UNIT - STRUCTURE SUIVANTE - ESTRUCTURA SEGUIDA - ZUSATZSTRUKTUR**

1 struttura alluminio L. 180 cm 7KFRAME3S-AL
5 pannelli Industrial 24 mm - dimensione 20x160 cm

1 aluminium frame L. 180 cm 7KFRAME3S-AL
5 Industrial 24 mm panels - size 20x160 cm

1 structure en aluminium L. 180 cm 7KFRAME3S-AL
5 panneaux Industrial 24 mm - taille 20x160 cm

1 estructura de aluminio L. 180 cm 7KFRAME3S-AL
5 paneles Industrial 24 mm - dimensión 20x160 cm

1 Aluminiumstruktur L. 180 cm 7KFRAME3S-AL
5 Paneele Industrial 24 mm - Format 20x160 cm

Superficie coperta 2,88 m²
Total area 2,88 m²
Surface couverte 2,88 m²
Superficie cubierta 2,88 m²
Überdachte Fläche 2,88 m²

Prezzo al m²
Preice per m²
Prix par m²
Precio por m²
Preis pro m²

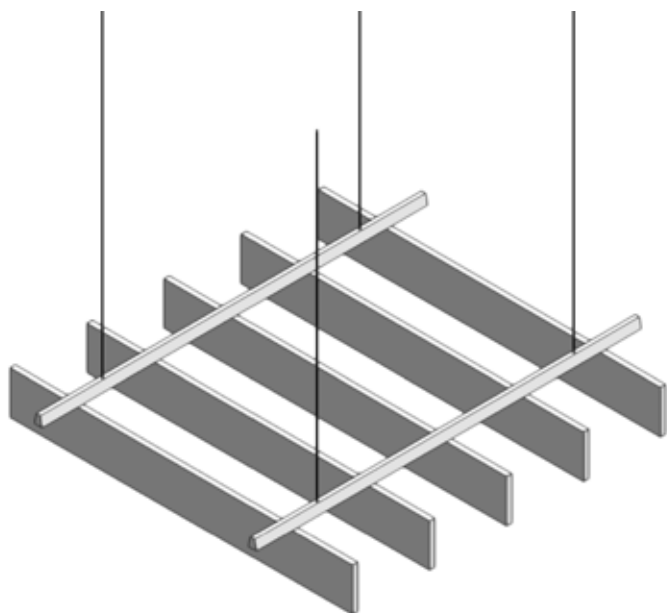

MODULO BASE - BASE UNIT - STRUCTURE DE BASE - ESTRUCTURA BASICA - BASISSTRUKTUR

1 struttura alluminio L. 180 cm 7KFRAME8-AL
5 pannelli Industrial 24 mm - dimensione 20x160 cm

1 aluminium frame L. 180 cm 7KFRAME8-AL
5 Industrial 24 mm panels - size 20x160 cm

1 structure en aluminium L. 180 cm 7KFRAME8-AL
5 panneaux Industrial 24 mm - taille 20x160 cm

1 estructura de aluminio L. 180 cm 7KFRAME8-AL
5 paneles Industrial 24 mm - dimensión 20x160 cm

1 Aluminiumstruktur L. 180 cm 77KFRAME8-AL
5 Paneele Industrial 24 mm - Format 20x160 cm

Superficie coperta 2,88 m²
Total area 2,88 m²
Surface couverte 2,88 m²
Superficie cubierta 2,88 m²
Überdachte Fläche 2,88 m²

Prezzo al m²
Preice per m²
Prix par m²
Precio por m²
Preis pro m²

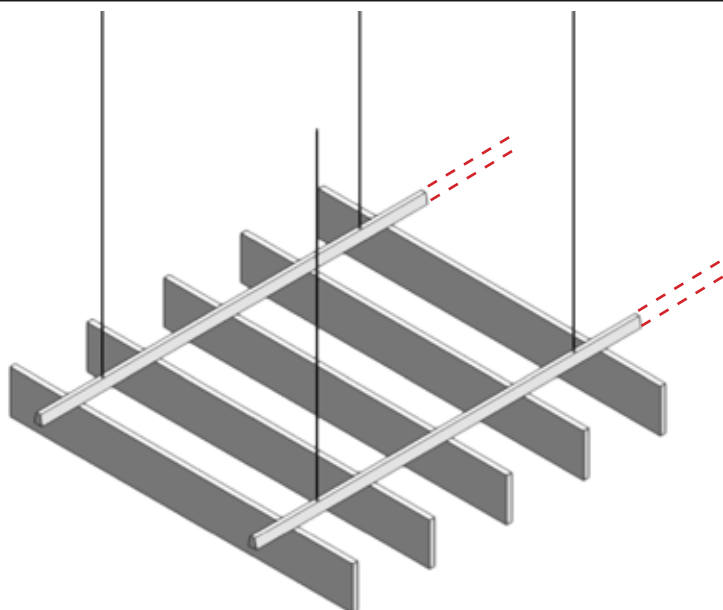

MODULO SEGUITO - ADD-ON UNIT - STRUCTURE SUIVANTE - ESTRUCTURA SEGUIDA - ZUSATZSTRUKTUR

1 struttura alluminio L. 180 cm 7KFRAME8S-AL
5 pannelli Industrial 24 mm - dimensione 20x160 cm

1 aluminium frame L. 180 cm 7KFRAME8S-AL
5 Industrial 24 mm panels - size 20x160 cm

1 structure en aluminium L. 180 cm 7KFRAME8S-AL
5 panneaux Industrial 24 mm - taille 20x160 cm

1 estructura de aluminio L. 180 cm 7KFRAME8S-AL
5 paneles Industrial 24 mm - dimensión 20x160 cm

1 Aluminiumstruktur L. 180 cm 77KFRAME8S-AL
5 Paneele Industrial 24 mm - Format 20x160 cm

Superficie coperta 2,88 m²
Total area 2,88 m²
Surface couverte 2,88 m²
Superficie cubierta 2,88 m²
Überdachte Fläche 2,88 m²

Prezzo al m²
Preice per m²
Prix par m²
Precio por m²
Preis pro m²



COMING SOON...

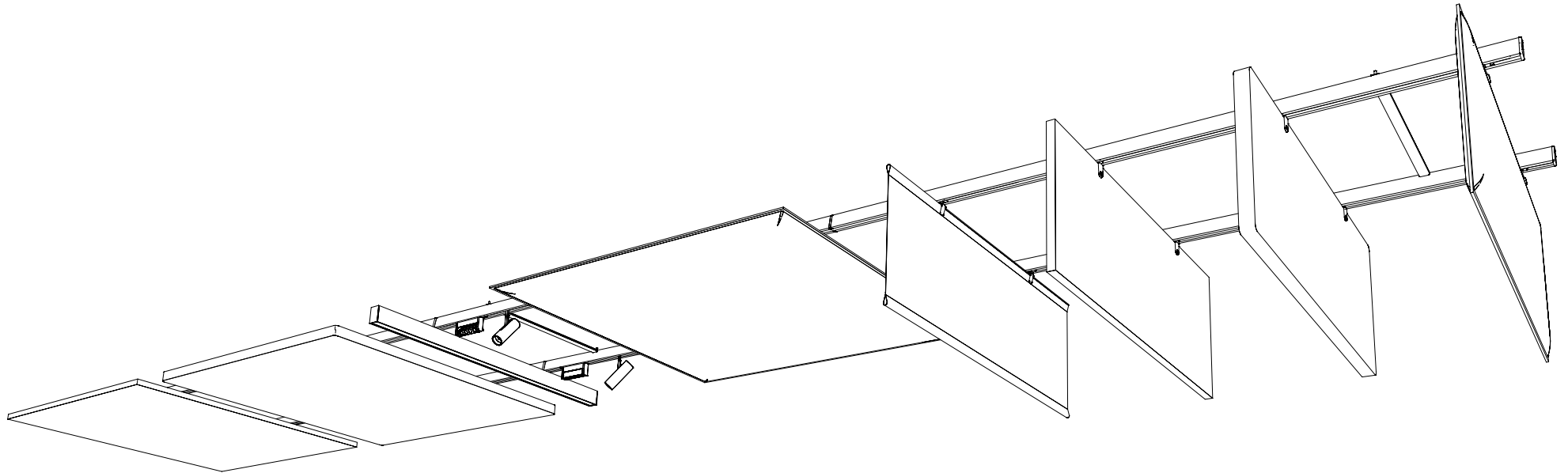

Il QR CODE qui riportato sarà attivo da settembre, con ulteriori pannelli, luci e accessori che arricchiranno la gamma.

The QR CODE shown here will be active from September, with more panels, lights and accessories adding to the range.

Le QR CODE présenté ici sera actif à partir de septembre, et d'autres panneaux, lampes et accessoires viendront s'ajouter à la gamme.

El QR CODE que se muestra aquí estará activo a partir de septiembre, con más paneles, luces y accesorios que se sumarán a la gama.

Der hier gezeigte QR CODE wird ab September aktiv sein und weitere Paneele, Leuchten und Zubehörteile werden das Angebot ergänzen.



Deze informatie is afkomstig van de website van Zero-Z design / Akoestiekexpert.nl.

Voor vragen, toelichting en meer informatie kunt u contact opnemen met:

Zero-Z design

Modem 20b

7741 MJ Coevorden

T +31 (0)30 2201297

E info@zero-z-design.nl

W www.zero-z-design.nl

www.akoestiekexpert.nl

