

# **SNOWSOUND**

**Acoustics & Wellbeing technologies**

**Caimi**

**PRODUCTS LIST**

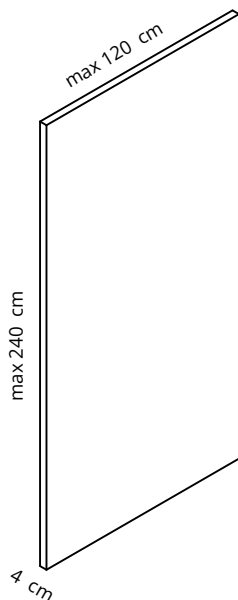

Pannello con imbottitura interna in poliestere a densità variabile, rivestimento esterno in tessuto Snowsound-Fiber Textiles 0, 3 Melange, 6 Velvet, 8 Bouclé, 14 Biosphere. Tempi di consegna 4/5 settimane (mese di agosto escluso).

- tolleranza sulle dimensioni  $\pm 3$  mm

**PER DIMENSIONI, FORME E COLORI NON COMPRESI IN QUESTO LISTINO PREZZI, CONTATTATE IL NOSTRO UFFICIO COMMERCIALE.**

**Per composizioni che prevedono l'utilizzo di forme, dimensioni e/o materiali diversi tra loro, contattare l'ufficio commerciale**

**N.B. lo spessore dei pannelli Snowcustom è ora di 4 cm. Per completamenti di composizioni già installate, contattare il nostro ufficio commerciale**

**CONDIZIONI COMMERCIALI**

- Considerata la lavorazione artigianale di Snowcustom, è richiesto un anticipo del 50% del valore al momento dell'ordine.

Panel with variable-density polyester internal padding, outer cover in Snowsound-Fiber Textiles 0, 3 Melange, 6 Velvet, 8 Bouclé, 14 Biosphere. Lead time 4/5 weeks (month of August excluded).

- tolerance on dimensions  $\pm 3$  mm

**FOR DIMENSIONS, SHAPES AND COLOURS NOT INCLUDED IN THIS PRICE LIST, PLEASE CONTACT OUR SALES DEPARTMENT.**

**For compositions using different shapes, sizes and/or materials, please contact the sales department. N.B. the thickness of Snowcustom panels is now 4 cm. For completions of already installed compositions, please contact our sales department.**

**SALES CONDITIONS**

- Due to the handcrafted manufacture of Snowcustom, an advance payment of 50% of the value is required at the time of order.

Panneau avec rembourrage interne en polyester à densité variable, revêtement externe en tissu Snowsound-Fiber Textiles 0, 3 Melange, 6 Velvet, 8 Bouclé, 14 Biosphere. Délai d'expédition 4/5 semaines (sauf le mois d'Août).

- tolérance sur les dimensions  $\pm 3$  mm

**POUR LES DIMENSIONS, FORMES ET COULEURS NE FIGURANT PAS DANS CETTE LISTE DE PRIX, VEUILLEZ CONTACTER NOTRE SERVICE COMMERCIAL.**

**Pour des compositions utilisant des formes, des tailles et/ou des matériaux différents, veuillez contacter le service commercial. N.B.**

**l'épaisseur des panneaux Snowcustom est désormais de 4 cm. Pour compléter des compositions déjà installées, veuillez contacter notre service commercial.**

**CONDITIONS COMMERCIALES**

- En raison de la fabrication artisanale de Snowcustom, un acompte de 50 % de la valeur est demandé au moment de la commande.

Panel con acolchado interior de poliéster de densidad variable, revestimiento exterior en Snowsound-Fiber Textiles 0, 3 Melange, 6 Velvet, 8 Bouclé, 14 Biosphere. Tiempos de entrega 4/5 semanas (mes de Agosto no incluido).

- tolerancia en las dimensiones  $\pm 3$  mm

**PARA DIMENSIONES, FORMAS Y COLORES NO INCLUIDOS EN ESTA LISTA DE PRECIOS, PÓNGASE EN CONTACTO CON NUESTRO DEPARTAMENTO DE VENTAS.**

**Para composiciones con formas, tamaños y/o materiales diferentes, póngase en contacto con el departamento comercial. N.B. el grosor de los paneles Snowcustom es ahora de 4 cm. Para completar composiciones ya instaladas, póngase en contacto con nuestro departamento comercial.**

**CONDICIONES DE VENTA:**

- Debido a la fabricación artesanal de Snowcustom, se requerirá un anticipo del 50% del total a la realización del pedido.

Panel mit Polyester-Füllmaterial von unterschiedlicher Dichte, Außenbezug aus Snowsound-Fiber Textiles 0, 3 Melange, 6 Velvet, 8 Bouclé, 14 Biosphere. Lieferzeit 4/5 Wochen (ausgenommen August).

- Toleranz bei den Abmessungen  $\pm 3$  mm

**FÜR ABMESSUNGEN, FORMEN UND FARBEN, DIE NICHT IN DIESER PREISLISTE ENTHALTEN SIND, WENDEN SIE SICH BITTE AN UNSERE VERKAUFSABTEILUNG.**

**Für Kompositionen mit anderen Formen, Größen und/oder Materialien wenden Sie sich bitte an die Verkaufsabteilung. Die Dicke der Snowcustom Platten beträgt jetzt 4 cm. Für Ergänzungen von bereits installierten Kompositionen, kontaktieren Sie bitte unsere Verkaufsabteilung**

**VERKAUFSBEDINGUNGEN**

- Da es sich bei den Snowcustom Vorhängen ausschließlich um Sonderanfertigungen gemäß Kundenvorgaben handelt, ist zum Zeitpunkt der Bestellung eine Anzahlung von 50 % des Warenwertes erforderlich.

- + 40% sul prezzo del pannello
- + 40% on panel price
- + 40 % sur le prix du panneau
- + 40% sobre el precio del panel
- + 40% auf den Panelpreis



I pannelli Snowcustom possono essere forniti con tessuto riduttore di radiofrequenze. **Vedi pag. 34-35**

Snowcustom panels can be supplied with radio frequency reduction fabric. **See pages 34-35**

Les panneaux Snowcustom peuvent être fournis avec tissu réducteur des radiofréquences. **Voir pages 34-35**

Los panels Snowcustom pueden suministrarse con tejido reductor de radiofrecuencias. **Ver páginas 34-35**

Snowcustom Paneele können mit Radiofrequenz-Reduziergewebe geliefert werden. **Siehe Seiten 34-35**

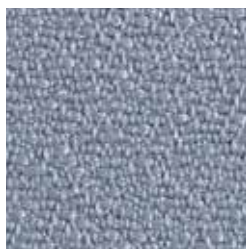
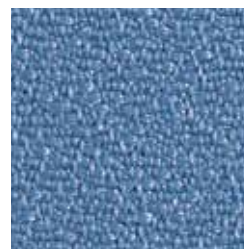
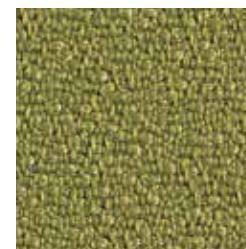

**COLORI DISPONIBILI  
AVAILABLE COLORS****FIBER 0****8002****8004****8007****6046****7004****1008****COME ORDINARE:**

Scegliere il tipo di rivestimento **7SCF0 = SNOWCUSTOM FIBER 0**

Scegliere il colore per il tipo di rivestimento scelto (ad esempio, per Fiber 0: 8002)

Indicare le dimensioni L (lunghezza) e H (altezza), ad esempio 120x140

Il codice da ordinare sarà: **7SCF0-8002 120x140**

**HOW TO ORDER:**

Choose the type of covering **7SCF0 = SNOWCUSTOM FIBER 0**

Choose the colour for the chosen type of covering (e.g. for Fiber 0: 8002)

Indicate the dimensions L (length) and H (height), e.g. 120x140

The ordering code will be: **7SCF0-8002 120x140**

**COMMENT COMMANDER:**

Choisissez le type de revêtement **7SCF0 = SNOWCUSTOM FIBER 0**

Choisissez la couleur pour le type de revêtement choisi (ex. pour Fiber 0 : 8002)

Indiquez les dimensions L (longueur) et H (hauteur), ex. 120x140

Le code de commande sera: **7SCF0-8002 120x140**

**CÓMO PEDIRLO:**

Elija el tipo de revestimiento **7SCF0 = SNOWCUSTOM FIBER 0**

Elija el color para el tipo de revestimiento elegido (por ejemplo, para Fiber 0: 8002)

Indique las dimensiones L (longitud) y H (altura), por ejemplo 120x140

El código de pedido será: **7SCF0-8002 120x140**

**BESTELLUNGSVORGANG:**

Wählen Sie die Art des Belags **7SCF0 = SNOWCUSTOM FIBER 0**

Wählen Sie die Farbe für den gewählten Belagstyp (z.B. für Fiber 0: 8002)

Geben Sie die Abmessungen L (Länge) und H (Höhe) an, z.B. 120x140

Der Bestellcode lautet: **7SCF0-8002 120x140**

**ATTENZIONE.** Il valore della larghezza deve sempre essere inferiore al valore dell'altezza.

**ATTENTION** The value of the width must always be less than the value of the height.

**ATTENTION** La valeur de la largeur doit toujours être inférieure à la valeur de la hauteur.

**ATENCIÓN** El valor de la anchura debe ser siempre inferior al valor de la altura.

**ACHTUNG** Der Wert für die Breite muss immer kleiner sein als der Wert für die Höhe.

**PER DIMENSIONI, FORME E COLORI NON COMPRESI IN QUESTO LISTINO PREZZI, CONTATTATE IL NOSTRO UFFICIO COMMERCIALE.**

**FOR DIMENSIONS, SHAPES AND COLOURS NOT INCLUDED IN THIS PRICE LIST, PLEASE CONTACT OUR SALES DEPARTMENT.**

**POUR LES DIMENSIONS, FORMES ET COULEURS NE FIGURANT PAS DANS CETTE LISTE DE PRIX, VEUILLEZ CONTACTER NOTRE SERVICE COMMERCIAL.**

**PARA DIMENSIONES, FORMAS Y COLORES NO INCLUIDOS EN ESTA LISTA DE PRECIOS, PÓNGASE EN CONTACTO CON NUESTRO DEPARTAMENTO DE VENTAS.**

**FÜR ABMESSUNGEN, FORMEN UND FARBEN, DIE NICHT IN DIESER PREISLISTE ENTHALTEN SIND, WENDEN SIE SICH BITTE AN UNSERE VERKAUFSABTEILUNG.**

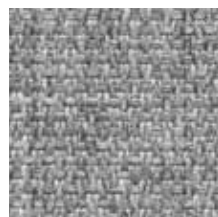

**COLORI DISPONIBILI**  
**AVAILABLE COLORS**  
**FIBER 3 MELANGE**

300



302

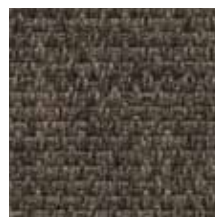

303



304

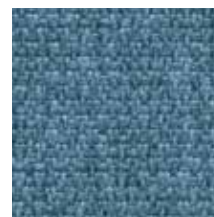

305



308

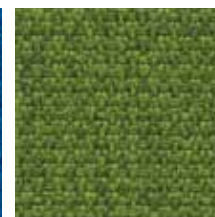

309

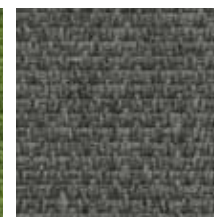

311

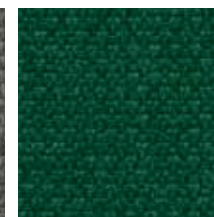

313



314

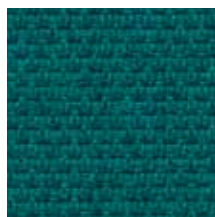

315



316



317

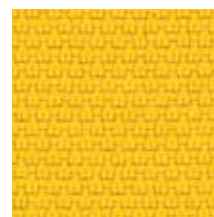

318

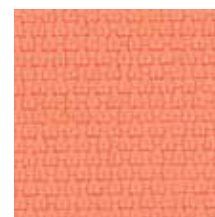

319

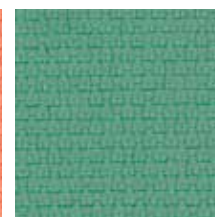

320

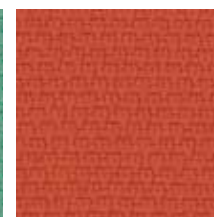

321



322

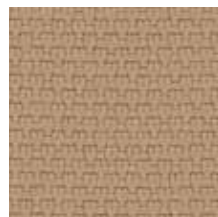

323



324



325

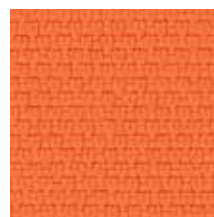

326



327

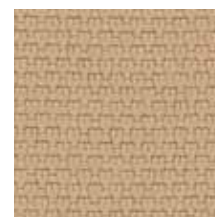

328

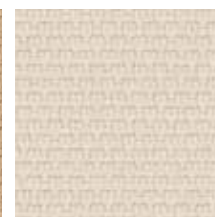

329

**COME ORDINARE:**Scegliere il tipo di rivestimento **7SCF3 = SNOWCUSTOM FIBER 3**

Scegliere il colore per il tipo di rivestimento scelto (ad esempio, per Fiber 3: 300)

Indicare le dimensioni L (lunghezza) e H (altezza), ad esempio 120x140

Il codice da ordinare sarà: **7SCF3-300 120x140****HOW TO ORDER:**Choose the type of covering **7SCF3 = SNOWCUSTOM FIBER 3**

Choose the colour for the chosen type of covering (e.g. for Fiber 3: 300)

Indicate the dimensions L (length) and H (height), e.g. 120x140

The ordering code will be: **7SCF3-300 120x140****COMMENT COMMANDER:**Choisissez le type de revêtement **7SCF3 = SNOWCUSTOM FIBER 3**

Choisissez la couleur pour le type de revêtement choisi (ex. pour Fiber 3: 300)

Indiquez les dimensions L (longueur) et H (hauteur), ex. 120x140

Le code de commande sera: **7SCF3-300 120x140****CÓMO PEDIRLO:**Elija el tipo de revestimiento **7SCF3 = SNOWCUSTOM FIBER 3**

Elija el color para el tipo de revestimiento elegido (por ejemplo, para Fiber 3: 300)

Indique las dimensiones L (longitud) y H (altura), por ejemplo 120x140

El código de pedido será: **7SCF3-300 120x140****BESTELLUNGSVORGANG:**Wählen Sie die Art des Belags **7SCF3 = SNOWCUSTOM FIBER 3**

Wählen Sie die Farbe für den gewählten Belagstyp (z.B. für Fiber 3: 300)

Geben Sie die Abmessungen L (Länge) und H (Höhe) an, z.B. 120x140

Der Bestellcode lautet: **7SCF3-300 120x140****ATTENZIONE.** Il valore della larghezza deve sempre essere inferiore al valore dell'altezza.**ATTENTION** The value of the width must always be less than the value of the height.**ATTENTION** La valeur de la largeur doit toujours être inférieure à la valeur de la hauteur.**ATENCIÓN** El valor de la anchura debe ser siempre inferior al valor de la altura.**ACHTUNG** Der Wert für die Breite muss immer kleiner sein als der Wert für die Höhe.



**COLORI DISPONIBILI**  
**AVAILABLE COLORS**  
**FIBER 6 VELVET**

600

601

602

603

604

605

606

607



608

609

610

611

**COME ORDINARE:**Scegliere il tipo di rivestimento **7SCF6 = SNOWCUSTOM FIBER 6**

Scegliere il colore per il tipo di rivestimento scelto (ad esempio, per Fiber 6: 600)

Indicare le dimensioni L (lunghezza) e H (altezza), ad esempio 120x140

Il codice da ordinare sarà: **7SCF6-600 120x140****HOW TO ORDER:**Choose the type of covering **7SCF6 = SNOWCUSTOM FIBER 6**

Choose the colour for the chosen type of covering (e.g. for Fiber 6: 600)

Indicate the dimensions L (length) and H (height), e.g. 120x140

The ordering code will be: **7SCF6-600 120x140****COMMENT COMMANDER:**Choisissez le type de revêtement **7SCF6 = SNOWCUSTOM FIBER 6**

Choisissez la couleur pour le type de revêtement choisi (ex. pour Fiber 6: 600)

Indiquez les dimensions L (longueur) et H (hauteur), ex. 120x140

Le code de commande sera: **7SCF6-600 120x140****CÓMO PEDIRLO:**Elija el tipo de revestimiento **7SCF6 = SNOWCUSTOM FIBER 6**

Elija el color para el tipo de revestimiento elegido (por ejemplo, para Fiber 6: 600)

Indique las dimensiones L (longitud) y H (altura), por ejemplo 120x140

El código de pedido será: **7SCF6-600 120x140****BESTELLUNGSVORGANG:**Wählen Sie die Art des Belags **7SCF6 = SNOWCUSTOM FIBER 6**

Wählen Sie die Farbe für den gewählten Belagstyp (z.B. für Fiber 6: 600)

Geben Sie die Abmessungen L (Länge) und H (Höhe) an, z.B. 120x140

Der Bestellcode lautet: **77SCF6-600 120x140**

H max 240 cm

L max 120 cm

**ATTENZIONE**

I pannelli rivestiti in tessuto F6 Velvet vengono confezionati con tessuto con trama come da immagine.

Il valore della larghezza deve sempre essere inferiore al valore dell'altezza.

**ATTENTION**

F6 Velvet fabric-covered panels are manufactured with weft fabric as shown in the picture.

The value of the width must always be less than the value of the height.

**ATTENTION**

Les panneaux recouverts de tissu Velvet F6 sont fabriqués avec un tissu de trame comme indiqué sur l'image.

La valeur de la largeur doit toujours être inférieure à la valeur de la hauteur.

**ATENCIÓN**

Los paneles recubiertos de tejido F6 Velvet se fabrican con tejido de trama como se muestra en la imagen.

El valor de la anchura debe ser siempre inferior al valor de la altura.

**ACHTUNG**

Die stoffbezogenen F6 Velvet-Paneele werden mit Schussgewebe hergestellt, wie auf dem Bild zu sehen.

Der Wert für die Breite muss immer kleiner sein als der Wert für die Höhe.

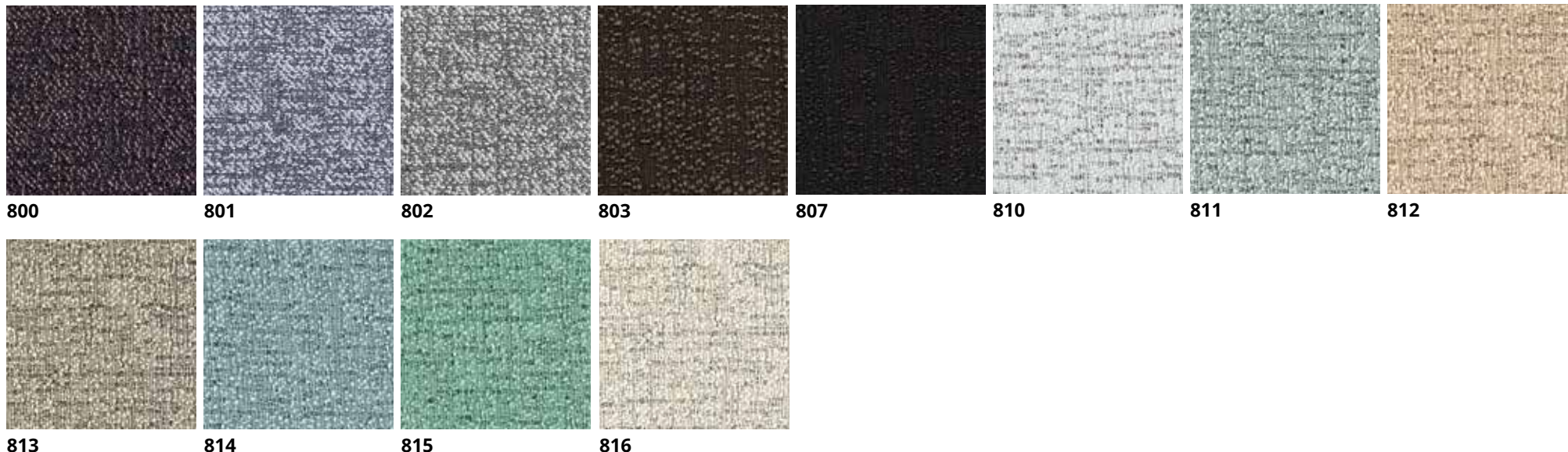

**COLORI DISPONIBILI**  
**AVAILABLE COLORS**  
**FIBER 8 BOUCLE'****COME ORDINARE:**Scegliere il tipo di rivestimento **7SCF8 = SNOWCUSTOM FIBER 8**

Scegliere il colore per il tipo di rivestimento scelto (ad esempio, per Fiber 8: 811)

Indicare le dimensioni L (lunghezza) e H (altezza), ad esempio 120x140

Il codice da ordinare sarà: **7SCF8-811 120x140****HOW TO ORDER:**Choose the type of covering **7SCF8 = SNOWCUSTOM FIBER 8**

Choose the colour for the chosen type of covering (e.g. for Fiber 8: 811)

Indicate the dimensions L (length) and H (height), e.g. 120x140

The ordering code will be: **7SCF8-811 120x140****COMMENT COMMANDER:**Choisissez le type de revêtement **7SCF8 = SNOWCUSTOM FIBER 8**

Choisissez la couleur pour le type de revêtement choisi (ex. pour Fiber 8: 811)

Indiquez les dimensions L (longueur) et H (hauteur), ex. 120x140

Le code de commande sera: **7SCF8-811 120x140****CÓMO PEDIRLO:**Elija el tipo de revestimiento **7SCF8 = SNOWCUSTOM FIBER 8**

Elija el color para el tipo de revestimiento elegido (por ejemplo, para Fiber 8: 811)

Indique las dimensiones L (longitud) y H (altura), por ejemplo 120x140

El código de pedido será: **7SCF8-811 120x140****BESTELLUNGSVORGANG:**Wählen Sie die Art des Belags **7SCF8 = SNOWCUSTOM FIBER 8**

Wählen Sie die Farbe für den gewählten Belagstyp (z.B. für Fiber 8: 811)

Geben Sie die Abmessungen L (Länge) und H (Höhe) an, z.B. 120x140

Der Bestellcode lautet: **7SCF8-811 120x140****ATTENZIONE.** Il valore della larghezza deve sempre essere inferiore al valore dell'altezza.**ATTENTION** The value of the width must always be less than the value of the height.**ATTENTION** La valeur de la largeur doit toujours être inférieure à la valeur de la hauteur.**ATENCIÓN** El valor de la anchura debe ser siempre inferior al valor de la altura.**ACHTUNG** Der Wert für die Breite muss immer kleiner sein als der Wert für die Höhe.



**COLORI DISPONIBILI**  
**AVAILABLE COLORS****FIBER 14 BIOSPHERE**

1401

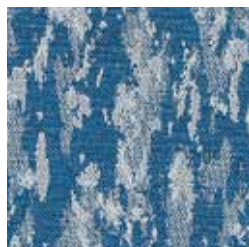

1402

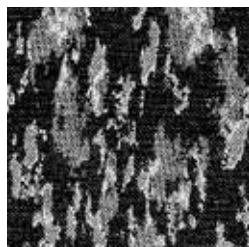

1404



1405

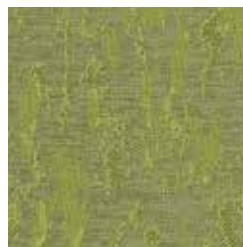

1406

**COME ORDINARE:**Scegliere il tipo di rivestimento **7SCF14 = SNOWCUSTOM FIBER 14**

Scegliere il colore per il tipo di rivestimento scelto (ad esempio, per Fiber 14: 1402)

Indicare le dimensioni L (lunghezza) e H (altezza), ad esempio 120x140

Il codice da ordinare sarà: **7SCF14-1402 120x140****HOW TO ORDER:**Choose the type of covering **7SCF14 = SNOWCUSTOM FIBER 14**

Choose the colour for the chosen type of covering (e.g. for Fiber 14: 1402)

Indicate the dimensions L (length) and H (height), e.g. 120x140

The ordering code will be: **7SCF14-1402 120x140****COMMENT COMMANDER:**Choisissez le type de revêtement **7SCF14 = SNOWCUSTOM FIBER 14**

Choisissez la couleur pour le type de revêtement choisi (ex. pour Fiber 814: 1402)

Indiquez les dimensions L (longueur) et H (hauteur), ex. 120x140

Le code de commande sera: **7SCF14-1402 120x140****CÓMO PEDIRLO:**Elija el tipo de revestimiento **7SCF14 = SNOWCUSTOM FIBER 14**

Elija el color para el tipo de revestimiento elegido (por ejemplo, para Fiber 14: 1402)

Indique las dimensiones L (longitud) y H (altura), por ejemplo 120x140

El código de pedido será: **7SCF14-1402 120x140****BESTELLUNGSVORGANG:**Wählen Sie die Art des Belags **7SCF14 = SNOWCUSTOM FIBER 14**

Wählen Sie die Farbe für den gewählten Belagstyp (z.B. für Fiber 14: 1402)

Geben Sie die Abmessungen L (Länge) und H (Höhe) an, z.B. 120x140

Der Bestellcode lautet: **7SCF14-1402 120x140**

L max 120 cm

H max 240 cm

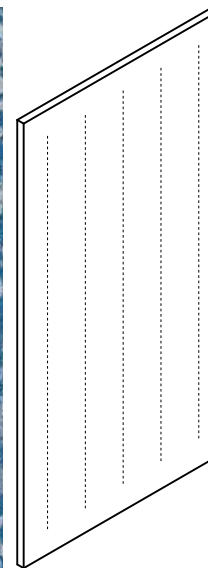
**ATTENZIONE**

I pannelli rivestiti in tessuto F14 Biosphere vengono confezionati con tessuto con trama come da immagine.

Il valore della larghezza deve sempre essere inferiore al valore dell'altezza.

**ATTENTION**

F14 Biosphere fabric-covered panels are manufactured with weft fabric as shown in the picture.

The value of the width must always be less than the value of the height.

**ATTENTION**

Les panneaux recouverts de tissu F14 Biosphere sont fabriqués avec un tissu de trame comme indiqué sur l'image.

La valeur de la largeur doit toujours être inférieure à la valeur de la hauteur.

**ATENCIÓN**

Los paneles recubiertos de tejido F14 Biosphere se fabrican con tejido de trama como se muestra en la imagen.

El valor de la anchura debe ser siempre inferior al valor de la altura.

**ACHTUNG**

Die stoffbezogenen F14 Biosphere-Paneele werden mit Schussgewebe hergestellt, wie auf dem Bild zu sehen.

Der Wert für die Breite muss immer kleiner sein als der Wert für die Höhe.



## 7S378/4

Kit 4 pcs.

Kit 4 attacchi magnetici a parete per pannelli Snowcustom (viti non incluse).

Kit of 4 magnetic wall mounts for Snowcustom panels (screws not included).

Kit de 4 supports muraux magnétiques pour les panneaux Snowcustom (vis non comprises).

Kit de 4 soportes magnéticos de pared para paneles Snowcustom (los tornillos no están incluidos).

Satz mit 4 magnetischen Wandhalterungen für Snowcustom-Panels (Schrauben nicht enthalten).

**Pannelli vedi pag. / Panels see pages 243-245-247-249-251**

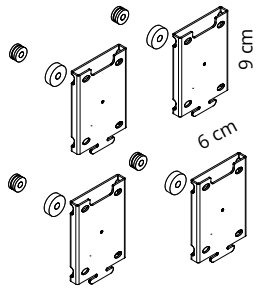

**4 pcs. = 1 code 7S378/4  
per pannelli dimensioni fino a 80x80**

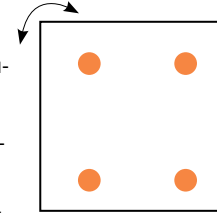
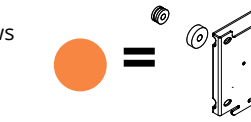

**Per pannelli dimensioni fino a 80x80 cm  
For panel sizes up to 80x80 cm  
Pour panneaux jusqu'à 80x80 cm  
Para paneles de dimensiones hasta 80x80 cm  
Für Plattengrößen bis zu 80x80**

## 7S378/6

Kit 6 pcs.

Kit 6 attacchi magnetici a parete per pannelli Snowcustom (viti non incluse).

Kit of 6 magnetic wall mounts for Snowcustom panels (screws not included).

Kit de 6 supports muraux magnétiques pour les panneaux Snowcustom (vis non comprises).

Kit de 6 soportes magnéticos de pared para paneles Snowcustom (los tornillos no están incluidos).

Satz mit 6 magnetischen Wandhalterungen für Snowcustom-Panels (Schrauben nicht enthalten).

**Pannelli vedi pag. / Panels see pages 243-245-247-249-251**

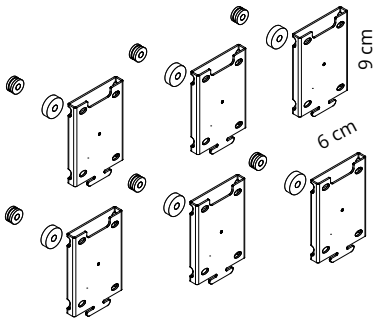

**6 pcs. = 1 code 7S378/6  
per pannelli dimensioni da 90x80 a 180x120**

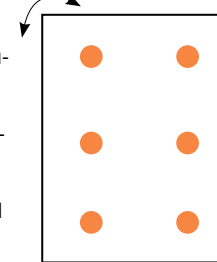
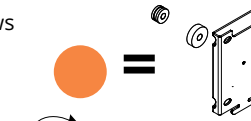

**Per pannelli dimensioni da 90x80 a 180x120 cm  
For panel sizes from 90x80 to 180x120 cm  
Pour panneaux de 90x80 à 180x120 cm  
Para paneles de dimensiones 90x80 a 180x120 cm  
Für Paneelgrößen von 90x80 bis 180x120 cm**

## 7S378/8

Kit 8 pcs.

Kit 6 attacchi magnetici a parete per pannelli Snowcustom (viti non incluse).

Kit of 6 magnetic wall mounts for Snowcustom panels (screws not included).

Kit de 6 supports muraux magnétiques pour les panneaux Snowcustom (vis non comprises).

Kit de 6 soportes magnéticos de pared para paneles Snowcustom (los tornillos no están incluidos).

Satz mit 6 magnetischen Wandhalterungen für Snowcustom-Panels (Schrauben nicht enthalten).

**Pannelli vedi pag. / Panels see pages 243-245-247-249-251**

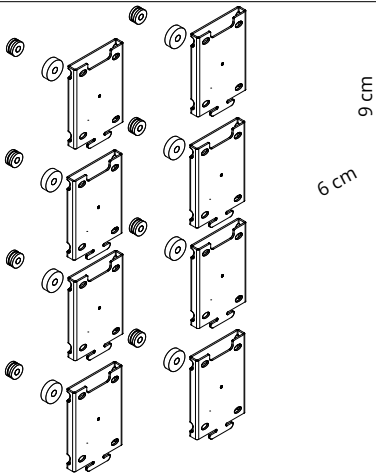

**8 pcs. = 1 code 7S378/8  
per pannelli dimensioni da 190x120 a 240x120**

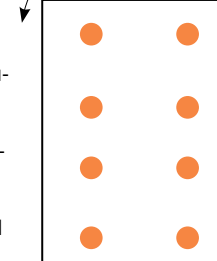
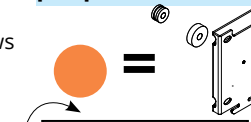

**Per pannelli dimensioni da 190x120 a 240x120 cm  
For panel sizes from 190x120 to 240x120 cm  
Pour panneaux de 190x120 à 240x120 cm  
Para paneles de dimensiones 190x120 a 240x120 cm  
Für Paneelgrößen von 190x120 bis 240x120 cm**

**OPZIONALE  
OPTIONAL**

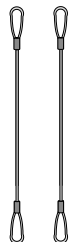

**7W/A3**

1 coppia / 1 pair  
1 paire / 1 pare  
1 Paar

Coppia di cavetti di sicurezza in acciaio per cod. 7S378/4  
7S378/6 E 7S378/8

Pair of steel safety cables for codes 7S378/4 7S378/6 E  
7S378/8

Paire de câbles de sécurité en acier pour 7S378/4  
7S378/6 E 7S378/8

Par de cablecillos de seguridad de acero para 7S378/4  
7S378/6 E 7S378/8

Ein Paar Sicherheitsseile aus Stahl für Art. 7S378/4  
7S378/6 E 7S378/8

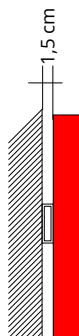
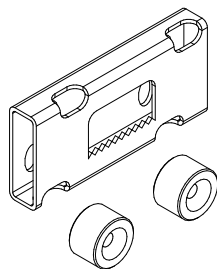

**7S377**

Attacco a parete in metallo verniciata per aggancio  
a chiodi/ganci, completo di 2 distanziali.

Painted metal wall mount for nail/hook attach-  
ment, complete with 2 spacers.

Fixation murale en métal peint pour fixation par  
clou ou crochet, complète avec 2 entretoises.

Fijación mural de metal pintado para fijación  
clavo/gancho, completa con 2 distanciadores

Wandbefestigung aus lackiertem Metall für Nagel-/  
Hakenbefestigung, komplett mit 2 Abstandshal-  
tern

**2 pcs. = 2 code 7S377**  
**Solo per dimensioni fino a 160x120**  
**Only for dimensions up to 160x120**

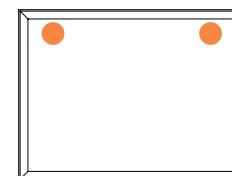
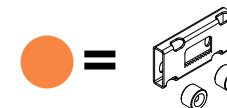

**Utilizzare sempre 2 cod. 7S377**  
**Always use 2 codes 7S377**  
**Toujours utiliser 2 codes 7S377**  
**Utilice siempre 2 cod. 7S377**  
**Verwenden Sie immer 2 Code 7S377**



**FIBER 0**



**FIBER 3 MELANGE**



**FIBER 8 BOUCLE'**



**FIBER 6 VELVET**

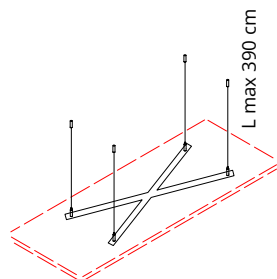

**FIBER 14 BIOSPHERE**

**7INCF/1**

Struttura per fissaggio a soffitto per pannelli Snowcustom:  
 Frame for Snowcustom panels ceiling fixing:  
 Structure pour accrochage au plafond pour panneaux Snowcustom:  
 Estructura para el montaje al techo para paneles Snowcustom:  
 Rahmen für die Deckenbefestigung für Snowcustom Paneele:

**70x60 cm - 70x70 cm - 80x40 cm - 80x50 cm - 80x60 cm - 80x70 cm -  
 80x80 cm - 90x40 cm - 90x50 cm - 90x60 cm - 90x70 cm - 90x80 cm -  
 90x90 cm - 40x100 cm - 50x100 cm - 60x100 cm**

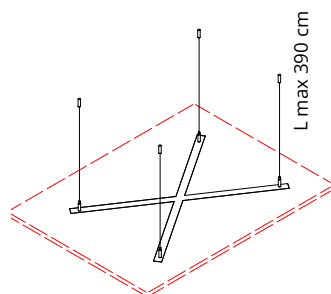
**7INCF/2**

Struttura per fissaggio a soffitto per pannelli Snowcustom:  
 Frame for Snowcustom panels ceiling fixing:  
 Structure pour accrochage au plafond pour panneaux Snowcustom:  
 Estructura para el montaje al techo para paneles Snowcustom:  
 Rahmen für die Deckenbefestigung für Snowcustom Paneele:

**70x100 cm - 80x100 cm - 90x100 cm - 100x100 cm - 40x110 cm -  
 50x110 cm - 60x110 cm - 70x110 cm - 80x110 cm - 90x110 cm -  
 100x110 cm - 110x110 cm - 40x120 cm - 50x120 cm - 60x120 cm -  
 70x120 cm - 80x120 cm - 90x120 cm - 100x120 cm - 110x120 cm -  
 120x120 cm - 40x130 cm - 50x130 cm - 60x130 cm - 70x130 cm -  
 80x130 cm - 90x130 cm - 100x130 cm - 110x130 cm - 120x130 cm -  
 40x140 cm - 50x140 cm - 60x140 cm - 70x140 cm**

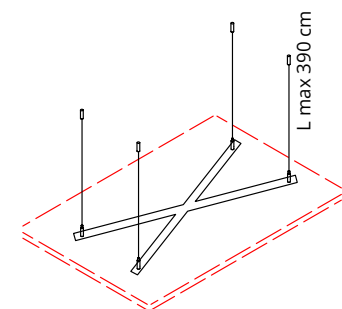
**7INCF/3**

Struttura per fissaggio a soffitto per pannelli Snowcustom:  
 Frame for Snowcustom panels ceiling fixing:  
 Structure pour accrochage au plafond pour panneaux Snowcustom:  
 Estructura para el montaje al techo para paneles Snowcustom:  
 Rahmen für die Deckenbefestigung für Snowcustom Paneele:

**80x140 cm - 90x140 cm - 100x140 cm - 110x140 cm - 120x140 cm -  
 40x150 cm - 50x150 cm - 60x150 cm - 70x150 cm - 80x150 cm -  
 90x150 cm - 100x150 cm - 110x150 cm - 120x150 cm - 40x160 cm -  
 50x160 cm - 60x160 cm - 70x160 cm - 80x160 cm - 90x160 cm -  
 100x160 cm - 110x160 cm - 120x160 cm**

**7OSF20060**

**7OSF20060M**

cad  
each ≥ 6 pz

Struttura per fissaggio a soffitto per pannelli Snowcustom:  
Frame for Snowcustom panels ceiling fixing:  
Structure pour accrochage au plafond pour panneaux Snowcustom:  
Estructura para el montaje al techo para paneles Snowcustom:  
Rahmen für die Deckenbefestigung für Snowcustom Paneele:

**60x200 cm**

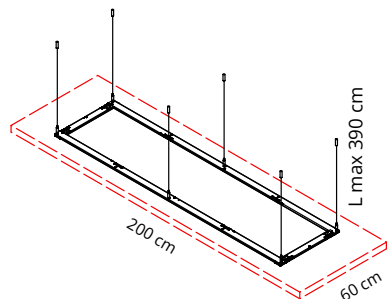

**7OSF200120**

**7OSF200120M**

cad  
each ≥ 6 pz

Struttura per fissaggio a soffitto per pannelli Snowcustom:  
Frame for Snowcustom panels ceiling fixing:  
Structure pour accrochage au plafond pour panneaux Snowcustom:  
Estructura para el montaje al techo para paneles Snowcustom:  
Rahmen für die Deckenbefestigung für Snowcustom Paneele:

**120x200 cm**

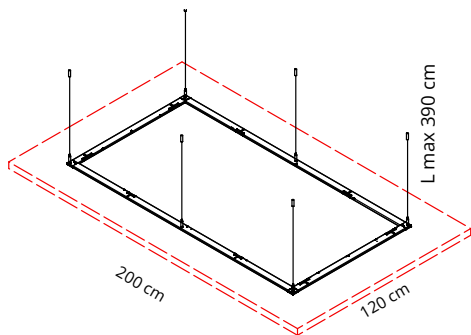

**7OSF24060**

**7OSF24060M**

cad  
each ≥ 6 pz

Struttura per fissaggio a soffitto per pannelli Snowcustom:  
Frame for Snowcustom panels ceiling fixing:  
Structure pour accrochage au plafond pour panneaux Snowcustom:  
Estructura para el montaje al techo para paneles Snowcustom:  
Rahmen für die Deckenbefestigung für Snowcustom Paneele:

**60x240 cm**

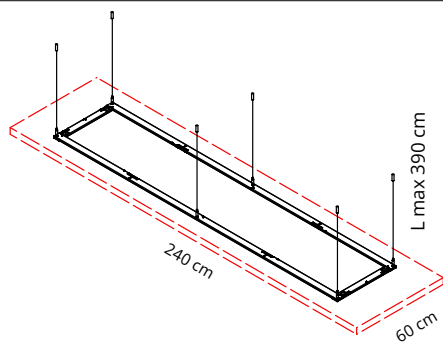

**7OSF240120**

**7OSF240120M**

cad  
each ≥ 6 pz

Struttura per fissaggio a soffitto per pannelli Snowcustom:  
Frame for Snowcustom panels ceiling fixing:  
Structure pour accrochage au plafond pour panneaux Snowcustom:  
Estructura para el montaje al techo para paneles Snowcustom:  
Rahmen für die Deckenbefestigung für Snowcustom Paneele:

**120x240 cm**

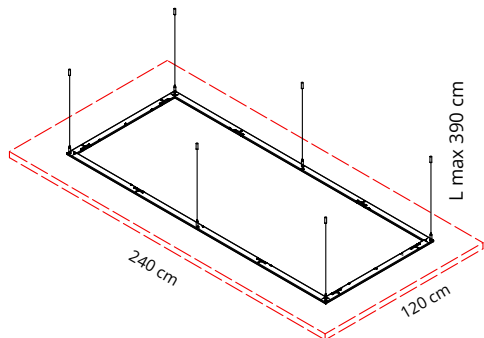

≥ 6 pz : Prezzo unitario per ordini ≥ 6 pz / Unit price for orders ≥ 6 pz / Prix unitaire pour commandes ≥ 6 pz  
Precio por unidad para pedidos ≥ 6 pz / Stückpreis für Bestellungen ≥ 6 pz

**7OCC1206****7OCC1206M**cad  
each ≥ 6 pz

Struttura per fissaggio a soffitto per pannelli Snowcustom:  
 Frame for Snowcustom panels ceiling fixing:  
 Structure pour accrochage au plafond pour panneaux Snowcustom:  
 Estructura para el montaje al techo para paneles Snowcustom:  
 Rahmen für die Deckenbefestigung für Snowcustom Paneele:

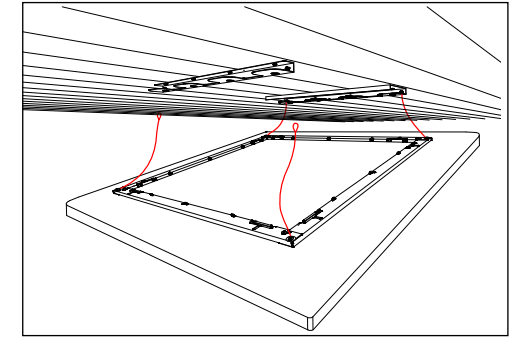
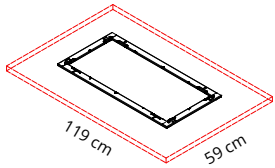
**60x120 cm****7OCC1606****7OCC1606M**cad  
each ≥ 6 pz

Struttura per fissaggio a soffitto per pannelli Snowcustom:  
 Frame for Snowcustom panels ceiling fixing:  
 Structure pour accrochage au plafond pour panneaux Snowcustom:  
 Estructura para el montaje al techo para paneles Snowcustom:  
 Rahmen für die Deckenbefestigung für Snowcustom Paneele:

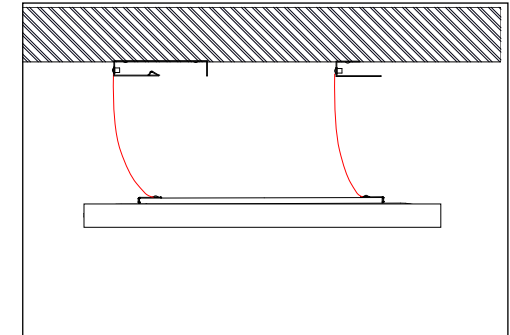
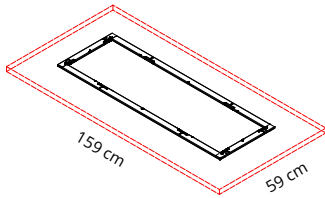
**60x160 cm****7OCC1212****7OCC1212M**cad  
each ≥ 6 pz

Struttura per fissaggio a soffitto per pannelli Snowcustom:  
 Frame for Snowcustom panels ceiling fixing:  
 Structure pour accrochage au plafond pour panneaux Snowcustom:  
 Estructura para el montaje al techo para paneles Snowcustom:  
 Rahmen für die Deckenbefestigung für Snowcustom Paneele:

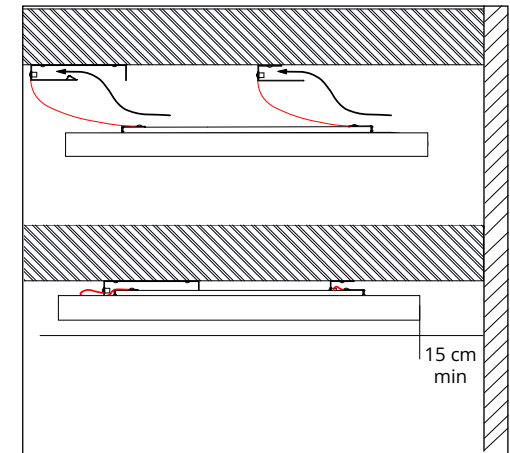
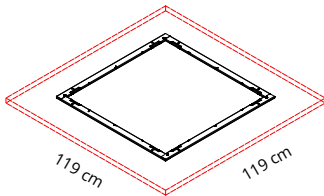
**120x120 cm****7OCC1216****7OCC1216M**cad  
each ≥ 6 pz

Struttura per fissaggio a soffitto per pannelli Snowcustom:  
 Frame for Snowcustom panels ceiling fixing:  
 Structure pour accrochage au plafond pour panneaux Snowcustom:  
 Estructura para el montaje al techo para paneles Snowcustom:  
 Rahmen für die Deckenbefestigung für Snowcustom Paneele:

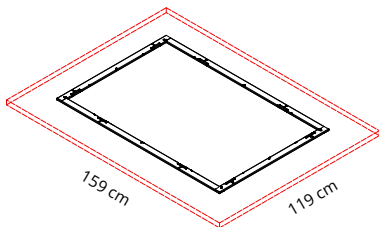
**120x160 cm**

≥ 6 pz : Prezzo unitario per ordini ≥ 6 pz / Unit price for orders ≥ 6 pz / Prix unitaire pour commandes ≥ 6 pz

Precio por unidad para pedidos ≥ 6 pz / Stückpreis für Bestellungen ≥ 6 pz

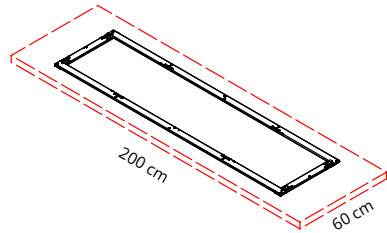

**7OCC2006**

**7OCC2006M**

cad  
each ≥ 6 pz

Struttura per fissaggio a soffitto per pannelli Snowcustom:  
Frame for Snowcustom panels ceiling fixing:  
Structure pour accrochage au plafond pour panneaux Snowcustom:  
Estructura para el montaje al techo para paneles Snowcustom:  
Rahmen für die Deckenbefestigung für Snowcustom Paneele:

**60x200 cm**

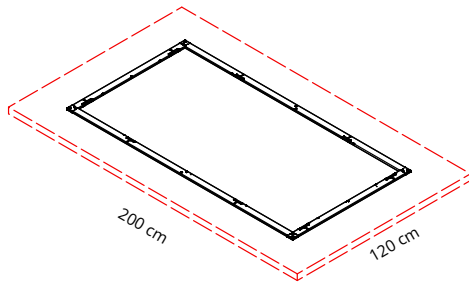

**7OCC2012**

**7OCC2012M**

cad  
each ≥ 6 pz

Struttura per fissaggio a soffitto per pannelli Snowcustom:  
Frame for Snowcustom panels ceiling fixing:  
Structure pour accrochage au plafond pour panneaux Snowcustom:  
Estructura para el montaje al techo para paneles Snowcustom:  
Rahmen für die Deckenbefestigung für Snowcustom Paneele:

**120x200 cm**

Deze informatie is afkomstig van de website van Zero-Z design / Akoestiekexpert.nl.

Voor vragen, toelichting en meer informatie kunt u contact opnemen met:

**Zero-Z design**

Modem 20b

7741 MJ Coevorden

**T** +31 (0)30 2201297

**E** [info@zero-z-design.nl](mailto:info@zero-z-design.nl)

**W** [www.zero-z-design.nl](http://www.zero-z-design.nl)

[www.akoestiekexpert.nl](http://www.akoestiekexpert.nl)

